



USER'S GUIDE

HAZ-DUST HD-1620TM **REAL-TIME HANDHELD MULTI-PARAMETER** **AIR Quality** **MONITOR**

MODEL HD-1620
DOC# HD1620 010722

Environmental Devices Corporation
Fieldstone Industrial Park
4 Wilder Drive Bldg. # 15
Plaistow, NH 03865
USA

Phone: (603) 378-2112
(800) 234-2589

Fax: (603) 378-2113

E-mail: sales@hazdust.com

E-mail: customerservice@hazdust.com

E-mail: techsupport@hazdust.com

Website: www.hazdust.com



**ENVIRONMENTAL
DEVICES CORPORATION**

Our instruments detect what's in the air we breathe.

U.S.A.

User's Guide

Licenses, Copyrights and Trademarks

This documentation contains trade secrets and confidential information proprietary to Environmental Devices Corporation (EDC). The software supplied with the instrumentation, documentation and any information contained therein may not be used, duplicated or disclosed to anyone, in whole or in part, other than as authorized in a fully executed EDC End User License or with the express written permission of EDC.

© 2021 Environmental Devices Corporation. All rights reserved throughout the world.

HAZ-DUST™ is a registered trademark of Environmental Devices Corporation. Other trademarks are the property of their respective holders.

Safety Notice

Repair of instrumentation supplied by Environmental Devices Corporation (EDC) should only be attempted by properly trained service personnel and should only be conducted in accordance with the EDC system documentation. Do not tamper with this hardware. High voltages may be present in all instrument enclosures. Use established safety precautions when working with this instrument.

The seller cannot foresee all possible modes of operation in which the user may attempt to utilize this instrumentation. The user assumes all liability associated with the use of this instrumentation. The seller further disclaims any responsibility for consequential damages.

Warranty

Products manufactured by Environmental Devices Corporation (EDC) are warranted against defects and workmanship for a period of one year from shipping date of original order to original purchaser at the original ship to address. An additional extended warranty is available for an additional year and follows the same terms and conditions. Any products or parts found defective by Environmental Devices Corp. within the stated warranty period will be replaced or repaired at EDC's discretion.

The warranty includes only instruments used in the manner the manufacturer (EDC) intended. The warranty does not cover misuse, negligence, accidents, acts of God, damage from shipping, incorrect cleaning and/or maintenance, unauthorized repairs, or any alterations and/or modifications including hardware, software, and consumables performed outside of the manufacture's facility.

Consumables and expendables are not covered under the manufactures warranty. Common examples include gas scrubbers, filters, O-rings, and batteries. Batteries will be covered for 90 days from ship date.

Modification of products or parts performed by any other person or entity other than EDC will void warranty.

If a repair or replacement is desired, communication with our technical support staff regarding any products or parts believed to be under warranty is mandated. Once communication is made a Return Merchandise Authorization number will be issued.

Products not manufactured by us are subject to the vendor/manufactures warranty policy.

Products manufactured and returned to EDC are subject to a 25% restocking fee.

Shipping to the factory is paid by the customer. EDC will assume shipping charges for all warranty repairs/replacements on the return to the original ship to address stated on initial Purchase Order issued to EDC when allocating equipment.

All returning equipment must be decontaminated of any harmful substances.

Any replacement parts will be warranted for 90 days from shipping date and the same terms and conditions as above apply.

1. Table of Contents

1. Section One	7
Introduction to the HD-1620	8
Real-Time Dust Monitoring Principles	9
Overview of the HD-1620	10
Features of the HD-1620.....	12
Specifications of the HD-1620.....	14
Components of the HD-1620	15
2. Section Two.....	16
Section 2- Operating Parameters of the HD-1620.....	17
Powering On & Off.....	18
Run Mode and Viewing Options	20
LED BAR.....	22
Using the Menus:.....	23
Particulate Size Fraction.....	25
PM- 2.5 Air Quality Index.....	28
Manually Activating Auto Purge	29
Setting the Alarm	30
Setting Engineering Units of Measurement.....	34
Setting Log Rate & Memory.....	36
Cross Calibration	37
Selecting Language	38
Setting Date and Time.....	39
Data Recording.....	41

Data Management	42
About & Maintenance Screen.....	44
Battery Maintenance	45
Replacing the Battery.....	47
Cleaning Sensor Optics.....	48
Flow Rate	49
Faults.....	50
Reviewing Stored Data.....	51
Uploading Data	52
Live Feed	53
DustComm Pro Software –.....	54
Opening Saved Data.....	59
Tool Bag.....	61
Live Feed	62
Change Units of Measurement	63
Appendix	63
Appendix A.....	64
Appendix B.....	68
Appendix C.....	69

1. Section One

Introduction to the HD-1620

Introduction to the HD-1620

Introduction

The HD-1620 is a handheld multi-parameter monitor. The HD-1620 records and logs PM-2.5, PM-10, PM-5.0, PM- 4.0 and PM-1.0 by using a selective size impactor. The instrument will display mass concentration along with a number count within the selected PM size distribution.

The HD-1620 will also display and log AQI based from CAL- OSHA. In addition, the HD-1620 monitors and logs Temperature, Humidity, Barometric Pressure and GPS.

Real-Time Dust Monitoring Principles

The traditional and real-time dust monitoring methods are described below.

Description of traditional method

Air is drawn by a vacuum pump through a filter typically either 25mm, 37mm or 47mm diameter membrane filter. The fibers and particles collected on the membrane filter must be counted or weighed in a laboratory for further analysis.

Advantages of traditional method

- OSHA compliance reference method.
- EPA compliance reference method.
- High level of specificity and accuracy.
- Collection of dust particles, which are available for further chemical analysis.

Description of real-time method

Dust particles are drawn into the sensor head and are detected once every second. Dust concentrations are instantaneously calculated and displayed on the HD-1620's touch screen display. All data points are stored in memory for later analysis.

Advantages of real-time method

- Immediate estimations of the concentration of a contaminant, permitting on-site evaluations.
- Provision of permanent 24-hour records of contaminant concentrations using continuous monitors.
- Internal audible alarm to warn workers of approaching hazardous situations.
- Reduction of number of manual tests.
- Reduction of number of laboratory analyses.
- Provision of more convincing evidence for presentation at hearings and litigation proceedings.
- Reduced cost of obtaining individual results.
- Ability to implement immediate engineering controls.

Overview of the HD-1620

Ease of use

- The user controls functionality and programming using menus displayed on the color touch screen.
- The instrument can be held by the hand, strapped to the hand or wrist, fastened to a belt or mounted to a tripod.
- Easy to use one button operation
- Go/No Go operation.
- User adjustable Ceiling and STEL alarms can be preset to alert the worker of approaching threshold limits.
- Easy to program Start/Stop Times.
- Multiple Language, time, date and unit of measurement formats.
- Large Touch Screen with sufficient back light

General Information

- The touch screen displays real-time concentration in milligram per cubic meter (mg/m^3 or ug/m^3) in accordance with OSHA, NIOSH, EPA Reference Methods
- Statistical information of all parameters is available and easily viewable at any time. This includes: 8 hr. TWA, STEL, cumulative average, minimum, maximum concentration levels, temperature, humidity, barometric pressure, AQI, flow rate, flow pressure, alarms levels, along with results of the self-diagnostics tests.
- The HD-1620 is calibrated using ISO 12103-1 Fine Test Dust (Arizona Road Dust).
- Calibrations include NIOSH 0600 methods for Respirable Dust and 0500 Method for Nuisance Dust with a $\pm 10\%$ accuracy.
- The calibration and flow of the HD-1620 can be easily adjusted.
- The recommend flow of 1.5 LPM is designed for use of our impactors PM-10, PM-5.0, PM-4.0, PM-2.5, PM-1.0.
- In addition to displaying mass concentration the instrument will also display a number count within the size distribution.

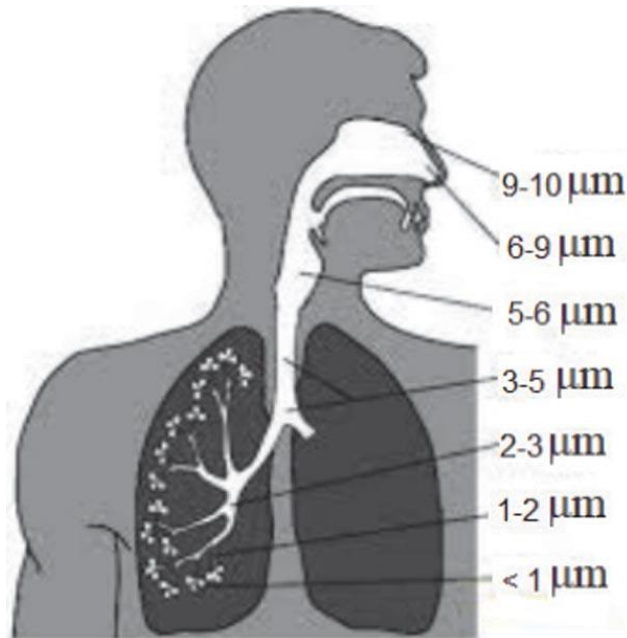

Figure 1. Diagram showing varying PM sizes in the respiratory system.

DustComm Pro Software

The HD-1620 ships complete with DustComm Pro software, which allows the user to look at real-time concentrations and graphs. The data in the instrument can be downloaded to a PC for further analysis.

DustComm Pro software is designed for more detailed analysis of sampled data. The use of icons and pull-down menus provide a user-friendly platform to store and analyze data and print management ready reports.

Data can easily be exported in comma-delimited files importable into spreadsheet programs such as Microsoft Excel.

The data plots provided with DustComm Pro enable:

- Detailed statistical analysis.
- Creation of graphics and charts.
- Mathematical correction of particle characteristics when aerosol significantly differs from calibration dust.
- Real time viewing of concentration values and real-time graphs.
- The ability to wirelessly communicate between the device and the software.

Features of the HD-1620

Introduction

The HD-1620 provides a unique combination of features to provide superior data quality, ease of use, and flexibility to the user. Below is a partial list of distinctive features.

Real-time display of

- Particulate exposure levels
- 8 hr., TWA, STEL, Cumulative average, Min, and Max levels
- PM-10, PM-5.0, PM-4.0, PM-2.5, PM-1.0
- Mass Concentration
- Number Reading within selective size PM fraction
- Unique on-screen programming of data sets
- Temperature, Humidity, Barometric Pressure and GPS coordinates.
- Flow rate
- Log rate
- Graphs
- Engineering units of measurement ug/m³, mg/m³, PM/cm³
- Infield calibration verification

Functional features

- Calibration to NIOSH methods for lung damaging particles.
- High sensitivity of 0.001-500 mg/m³ or 1-500,000 ug/m³
- Interchangeable size-selective sampling impactors.
- Pump and auto purge features.
- Audible and visual alarm features.

Operational features

- On-screen programming of sampling and data storage parameters.
- Ability to name data sets and dust profiles.
- Multiple date formats
- Menu options in multiple languages.
- Multiple user selectable audible alarm options
- In-field zero and span check of instrument calibration.
- Ability to Zero the instrument.
- Wireless communication.
- Ability to enter calibration factors.

Data management

- Choice of 1 second, 4 sec, 10 sec or 60 seconds averaging/storage intervals.

- Up to 15 days of stored data
- Memory storage of up to 43,000 data point or 15 days of storage.
- DustComm Pro Software supplied with a micro USB cable for downloading data to a PC. Data translation importable into Excel.

Security feature

The instrument will not power off when in active sampling mode. To power down the instrument, stop sampling and press the power off button.

To protect against accidental menu selection the user is prompted to confirm selection.

Specifications of the HD-1620

Introduction

The HD-1620 meets the following specifications.

Specifications

SPECIFICATION	RANGE
Calibration	NIOSH 0600 with SAE Test Dust
Accuracy	± 10%
Precision	0.02 mg/m ³
Sensing range	0.001-500 mg/m ³ or 1-500,000 ug/m ³
Particle size range	0.1-100 um
Recording time	1 second, 10 seconds, 30 seconds and 1 minute.
Flow rate	1.5 LPM User adjustable
Memory	43,200 data points
Output	Micro USB
Operating temperature	32 to 120° F (0° -50°C)
Humidity range	95% non-condensing
Battery	Rechargeable Lithium Ion Battery
Battery life	22 + hours
Charging time	3 hours
Size (case)	10" x 3.5" x 1.5"
Display Dimensions	3.5"
Weight	1.4 lbs.

Components of the HD-1620

Components

The following components ship with the HD-1620.

- HD-1620 Monitor.
- Hard Carrying Case
- Battery charger with US, UK, Asia, and European adapters
- Download cable
- Flow Adapter
- Interchangeable PM Impactor of PM-2.5.
- HD-1620 Multimedia USB Drive, Including: DustComm Pro Software and the Instruction Manual.
- Calibration Certificate
- Manufactures Warranty.

2. Section Two

Operating Parameters of the HD-1620

Section 2- Operating Parameters of the HD-1620

Introduction

This section describes the steps involved in starting the HD-1620 and configuring its operating parameters.

This section contains the following topics.

- Turning the HD-1620 on and off
- Run Mode and Viewing Options
- LED BAR
- Using the Menus
- Particulate Size Fraction
- Setting the Alarm
- PM- 2.5 Air Quality Index
- Setting Engineering Units of Measurement
- Setting Log Rate & Memory
- Cross Calibration
- Setting Log Rate & Memory
- Selecting the Language
- Setting the Date and Time
- Data Recording
- Data Management
- About Screen

Powering On & Off

Introduction

The battery must be fully charged before each use. See battery section for information on battery maintenance.

Power-ON

1. To turn the instrument on from a cold start, press the **ON/OFF** button on the top of the instrument to turn on the HD-1620 monitor On.
2. Once the instrument has finalized initializing tests, the user can press the grey “Action” button also referred to as the “Go/No Go” button to start sampling.



Power-OFF

1. The instrument will not power off when in active sampling mode. To power down the instrument, stop sampling then press the grey power off button on the top of the instrument.

NOTE: When the instrument is idle for 30 minutes the instrument will turn off. To turn back on Press the ON/OFF button.

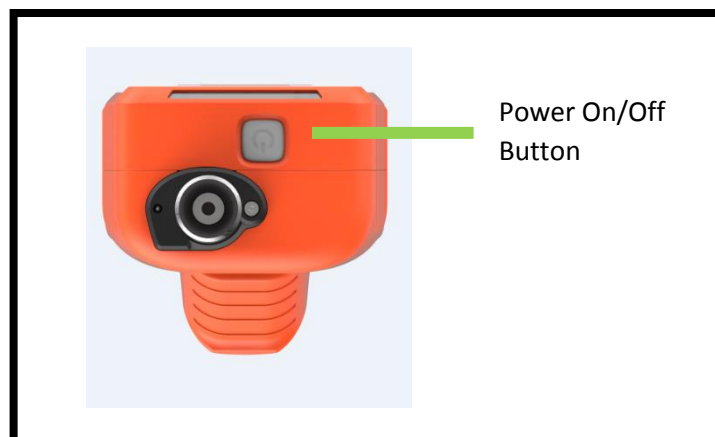

When the instrument is turned on the Splash Screen will appear.

The Splash Screen will show the following information:

Manufacturer
Product line
Serial Number
Firmware version
Battery life
Model
Last Calibration

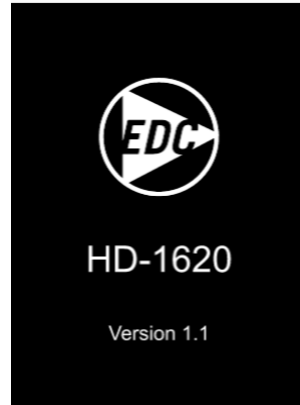

Note: Before taking a sample, fully charge battery for 3 hours.

When the HD-1620 is powered on it will enter a self-diagnostic test. This is indicated on the lower right corner of the screen as “Span Cal. or Zeroing (*depending on which stage the process is in*) Press to cancel.” There are two options to cancel the self-diagnostic test:

1. Users can press the “Press to Cancel” option to cancel the self-diagnostics
2. Rapidly, press the action button twice on the front of the instrument.



Option #1. Press the touch screen to cancel.

Option #2.
Press grey
Action Button



NOTE: The self-diagnostic can be stopped. However, prior to the first sample after powering on, the instrument will need to complete the diagnostic.

Run Mode and Viewing Options

Once the Self Diagnostic test is complete the instrument will automatically enter 'run mode viewing option one.' To change viewing options the user must select by pressing "View 1" on the touch screen. Once selected View 2 will appear.

View 1 consists of the following information. :

1. AQI for PM-2.5
2. Mass Concentration
3. PM COUNT – if selected
4. Temperature
5. Relative Humidity
6. Barometric Pressure
7. Elapsed time.

View 2 consists of the following information:

1. AQI for PM-2.5
2. Mass Concentration
3. PM Count if selected.
4. Elapsed time
5. Real-time rolling graph and user defined S.T.E.L and Ceiling alarms.



Note: The information bar containing time, date, and battery status is static and will remain on the top of the screen regardless of the screen selection.

When the sample is stopped the Statistics Mode will appear.

Note: When the instrument is idle for 30 minutes, the instrument will time out. Once timed out, the backlight will dim, when the instrument plugged in or charging, and will turn off when unplugged.

To turn the HD-1620 back on, press the Go/No Go button when charging. If idle and turned off then press the top power button to turn on.

Statistics Screen:

Once the sample run has stopped the statistics screen will appear. Use the white scroll bar located on the right side of the Touch Screen to scroll through all statistics

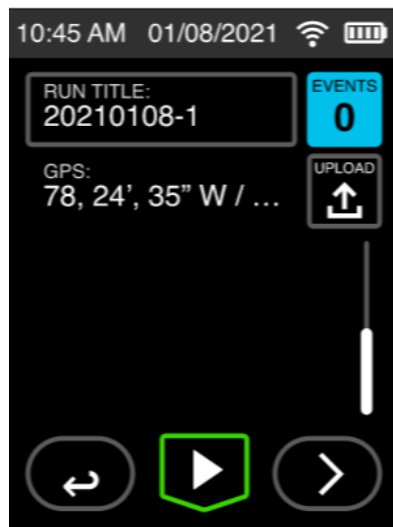
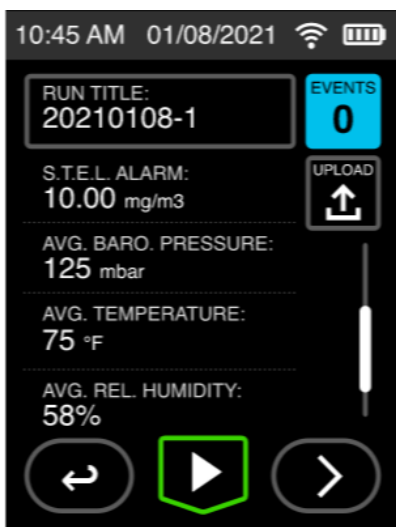
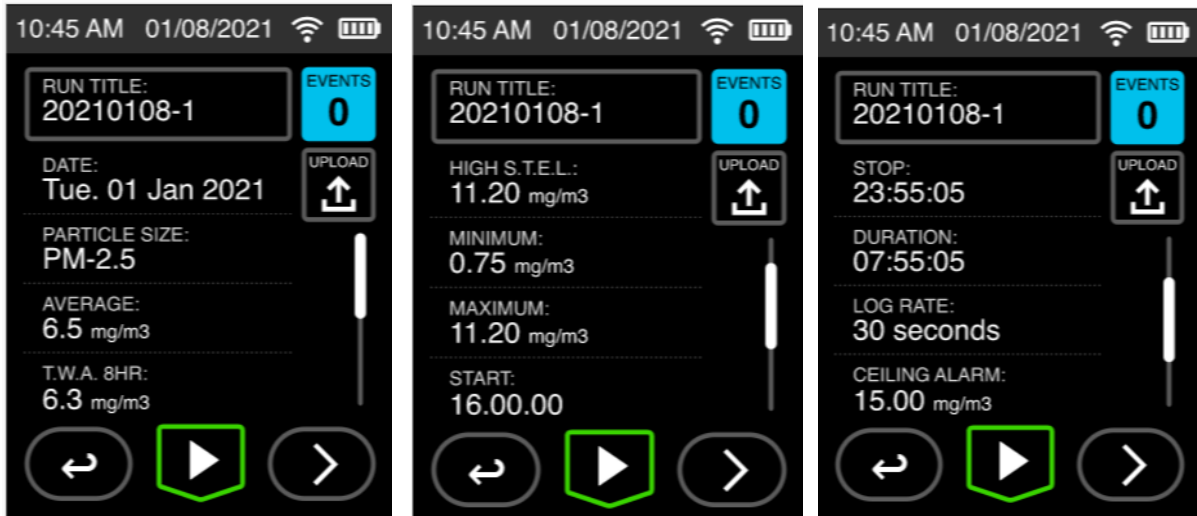

LED BAR



There is a LED bar on the top of the instrument that changes color as conditions change. The LEDs will run from left to right and/or flash depending on the condition.

The box around the real-time parameter readings will also change as conditions change.

The LED colors are:

Green: Normal operation

Movement of LED: move from right to left

Red/Pink: Ceiling Alarm, & Battery Fault (Pump/Pink)

Movement of LED: Flash

Orange: STEL Alarm

Movement of LED: flash

Blue: Auto Zero /Self Diagnostic Test

Movement of LED: Right to left.

Using the Menus:

Accessing the Data Sample Settings Menu

This menu can be accessed by pressing the back arrow on the statistics screen.

From the Data Sample Setting Menu also referred to as Home Screen users can:

1. Name a Data Set
2. View which PM impactor is in the instrument
3. Set Ceiling and S.T.E.L alarms
4. Select Sample Rate
5. Change units of measurement.
6. Entering a Calibration Scale Factor
7. Ability to start a sample.

Figure 1 Below: Data Sample Settings Menu also referred to as the Home Screen.

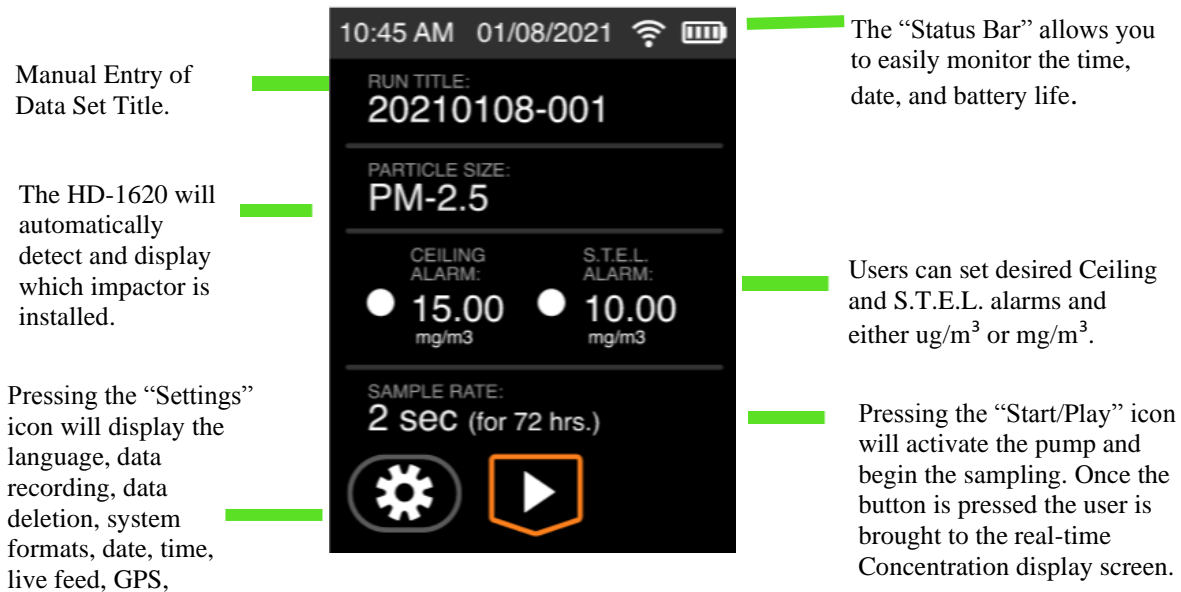

On Screen Programming through the Data Sample Settings Menu.

Naming Data Sets

1. Upon turning the device on for the first time, the run title will be empty. Press the Run Title to enter the name of a data set. Then press the green check mark or the selection will not save.

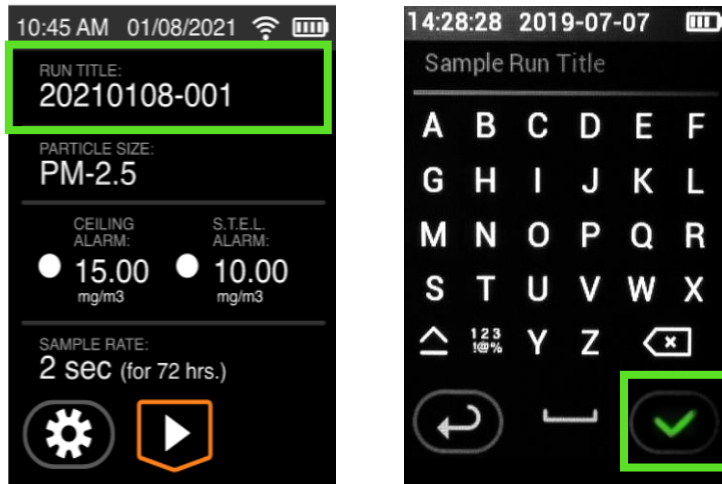

Note: When the device is powered off then turned back on; the run title will default to a date code. Every data set will have the same date code during that 24 hours with a numerical value after, indicating the number of data sets within the 24 hours. For example, 20210630-001 would indicate the first data set of June 30th, 2021. The second data set would read 20210630-002. To access previous data sets, use the “Settings” button and select “Data View.”

NOTE: When uploading data to a PC or laptop, all data sets are downloaded.

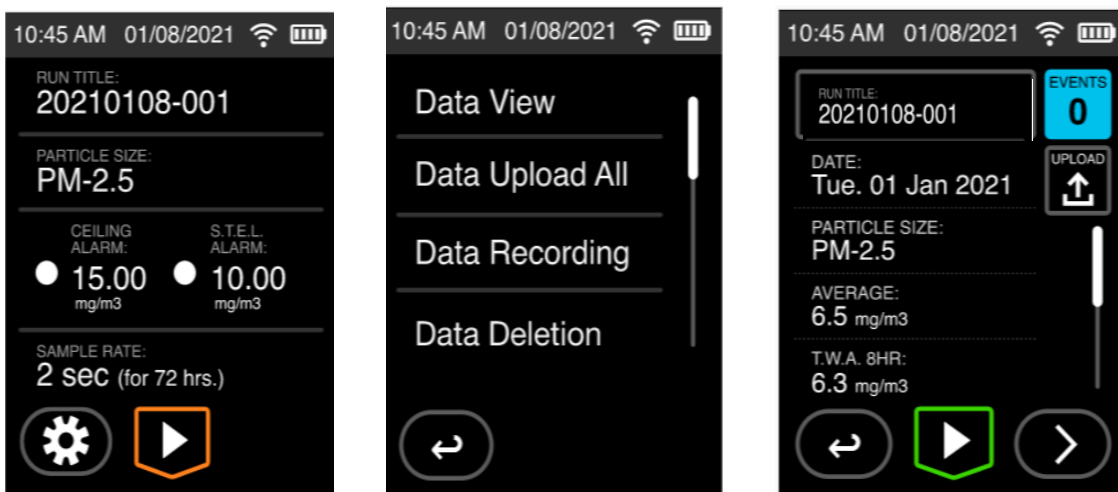

Particulate Size Fraction

Introduction

The HD-1620 uses inertial impactors for size separation of the Particle Matter. The inertial impactions require the use of Impactor Grease to work properly.

Once the impactor grease is applied, insert the impactor into the instrument. The instrument will be able to detect which impactor is inserted and will automatically populate the menu settings.

When an impactor is inserted, users cannot edit or change by overriding the systems automatic detection. If no impactor is installed, users can manually select a PM size by following the instructions below. However, if no impactor is installed the flow will not remain at the set flow rate.

If the user has a reason to manually enter a PM size by not inserting an impactor and is aware the flow will be affected, and the data will not accurately reflect the sample size this can be done.

1. From the Main Menu press Particle Size
2. Press the desired PM size
3. Press the green check mark to confirm selection.

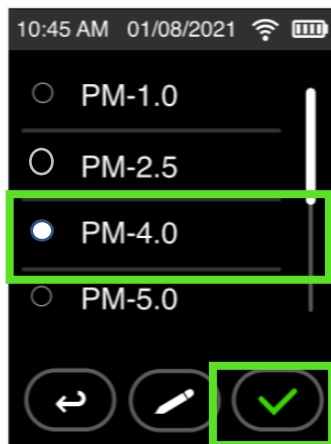

NOTE: The AQI will only work with the PM-2.5 impactor.



Inertial impactors require the use of Grease (P/N IG-105). The Multi-Purpose Synthetic Grease should be evenly applied to the impactor disk.

NOTE: The impactor will not function properly without the grease, which means the data will not be an accurate representation of the air sampled if grease is not applied.

Once the Grease is applied, snap the impactor onto the impactor disk.

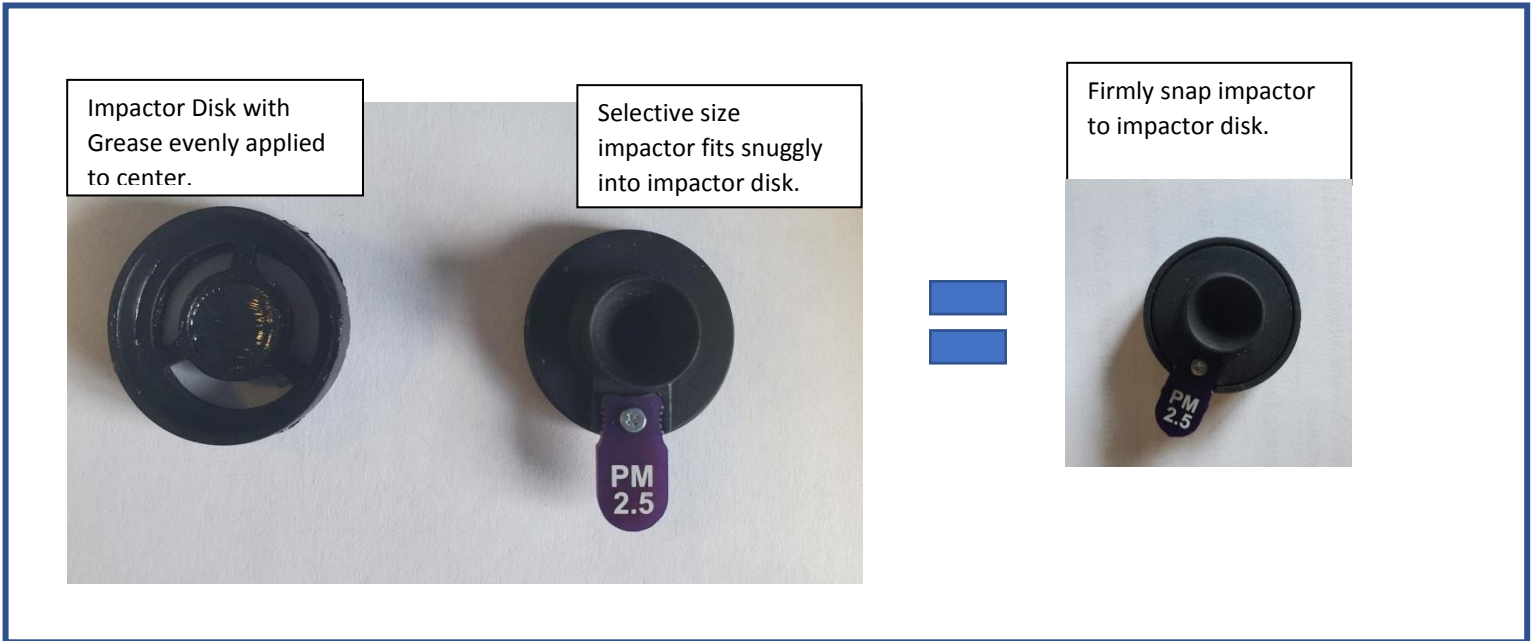

After the impactor is assembled line to tab of the impactor to the indentation on the Air Intake for the Impactor.

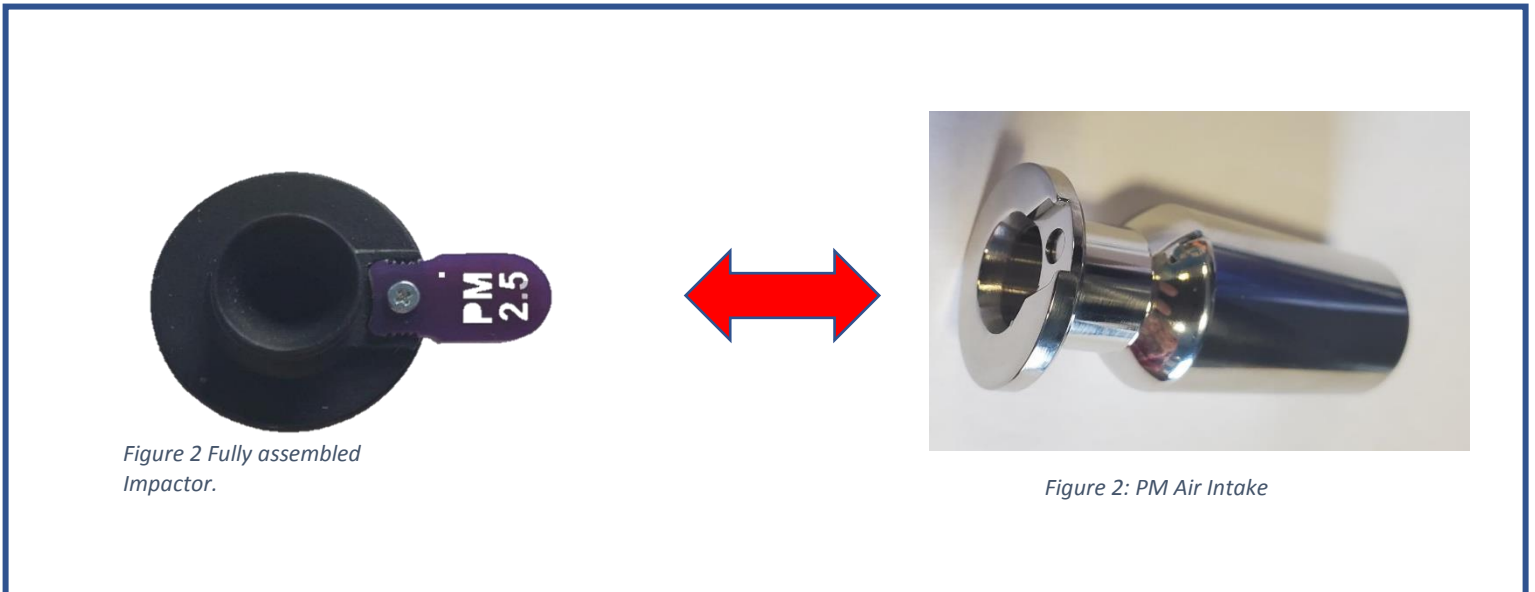

Next, take the PM Air Intake and insert to the top of the instrument as shown. DO NOT force the clasp around the air intake. When the Air Intake is seated properly, the clasp closes easily. If the clasp does not close, then take the air intake out and try again. Make sure the air intake and impactor are seated as deeply as possible. When done properly the clasp will easily close and the instrument will automatically detect the correctly installed PM size impactor.

The impactor cannot be installed without the air intake. If the impactor is installed without the air intake, the instrument will not automatically detect the correct PM size and the user will not receive proper flow.

Also, the PM Air Intake should not be used without an impactor. If the user wishes to sample Total Suspended Particles then the TSP impactor needs to be inserted. If the user has inserted the PM Air Intake without an impactor, this will also affect the flow rate.



PM- 2.5 Air Quality Index

The Air Quality Index is a useful tool. For example, Cal-OSHA uses an Air Quality Index to help employers comply with new regulations to ensure workers health and safety. An AQI can be used by Firefighters and first responders, Industrial Hygienists, consultants, law makers, schools and concerned citizens.

The HD-1620 AQI, offers a 1-Hour Average in a $\mu\text{g}/\text{m}^3$ value that will be used to calculate the AQI. The displayed AQI number will be based on the previous 60-minute average. If there are less than 60 minutes, the AQI will be based on the number of minutes that have recorded. This means the instrument will start to have an AQI number after only 1 minute of sampling.

The AQI is calculated only with PM-2.5. The PM-2.5 impactor must be inserted. The AQI is color coded and labeled on a scale ranging from Good through Hazardous and the AQI number is also displayed.

Below illustrate two examples; one with “Good” AQI and the other “Unhealthy.” Each example is shown with viewing option 1 and viewing option 2.



Figure 3: Example 1 AQI Good (41) View 1

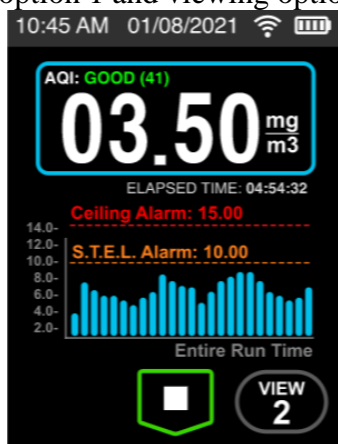

Figure 2: Example 1 AQI Good (41) View 2



Figure 3: Example 2. AQI Unhealthy (190) View 1

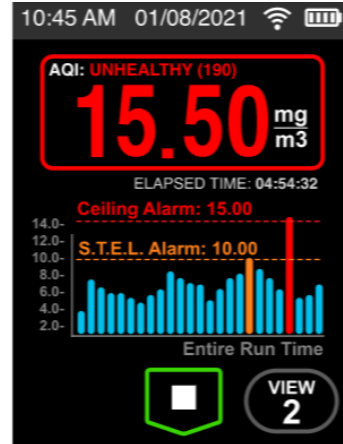

Figure 4: Example 2. AQI Unhealthy (190) View 2

The label or descriptive tag “Good-Hazardous” is color coded with the following colors corresponding the AQI.

■	GOOD: 0-50
■	MODERATE: 51-100
■	UNHEALTHY: 101-150
■	UNHEALTHY: 151-200
■	V. UNHEALTHY: 201-300
■	HAZARDOUS: 300+

The PM-2.5 AQI is derived by an average of PM-2.5 concentration in $\mu\text{g}/\text{m}^3$ and converted to AQI using Table 1.

NOTE: The color of the AQI is independent of the color on the outer box of the real-time concentration readings.

PM2.5 in Micrograms per Cubic Meter ($\mu\text{g}/\text{m}^3$)	Air Quality Index (AQI) Categories for PM2.5
0 to 12.0	0 to 50
12.1 to 35.4	51 to 100
35.5 to 55.4	101 to 150
55.5 to 150.4	151 to 200
150.5 to 250.4	201 to 300

Table 1. $\mu\text{g}/\text{m}^3$ to AQI Conversion.

Manually Activating Auto Purge

There may be a time the user would like to manually activate an auto zero or purge. This can easily be done by pressing the grey “Go/No Go” button on the front of the instrument. Once pressed the instrument will count down from three. Once the count down is complete the Auto Zero is activated. If the user wishes to cancel the Auto Purge the user can press and hold the grey button again. A dialog box will appear asking the user if they wish to cancel the run.

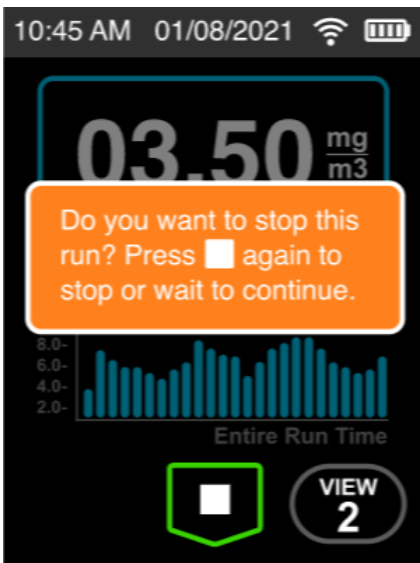
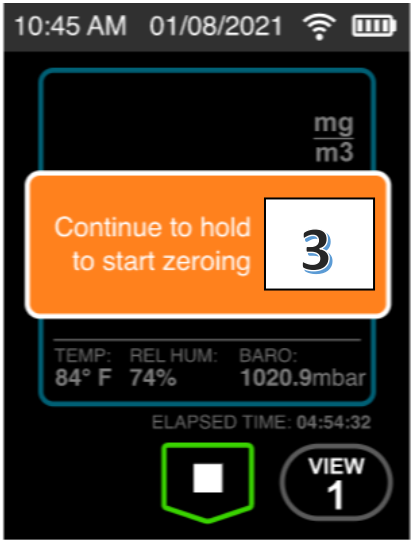

Setting the Alarm

Introduction

An audible alarm and visual alarm can be set to alert the worker of approaching threshold limits.

Alarm settings

The concentration level can be set to a defined agency standard for the particulate type being sampled or user's preference.

Using the alarm

There are two ways to set the alarm; by editing the PM profile or by clicking the alarm value. To set by changing the profile see instructions below.

1. From the "Data Sample Settings" menu press "Particle Size." This will open the particle profile. From here, the alarm along with other parameters may be set. Including the units of measurement.

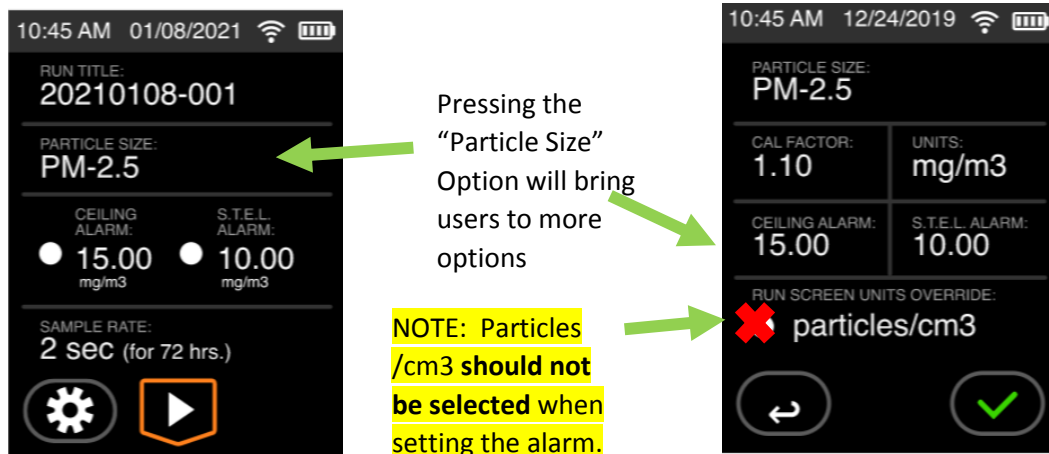

Alternatively, the alarm can be set by selecting the alarm value if no other parameters need to be changed.

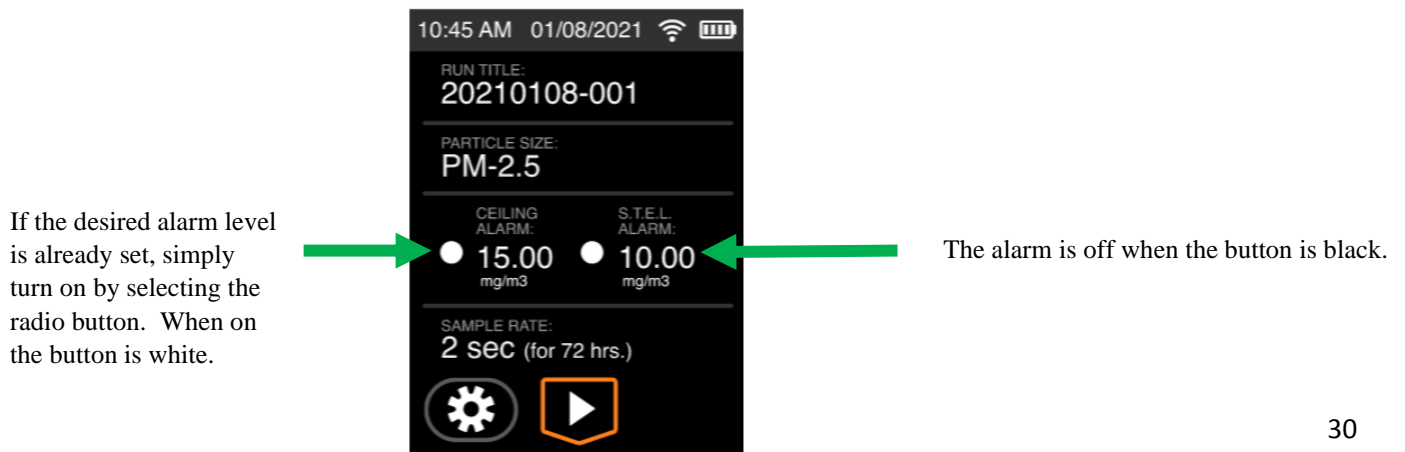

- Next select Ceiling or S.T.E.L alarm and enter desired selection. Press the green checkmark to confirm selection.

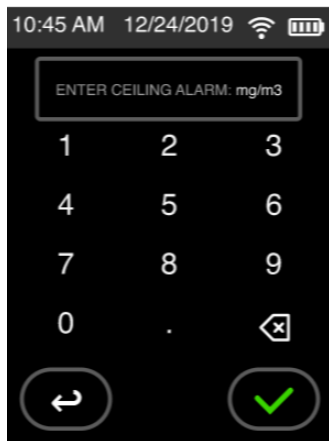

By pressing "Ceiling Alarm" users can set the numerical value.

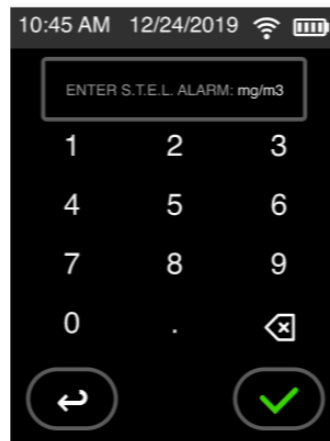

By pressing S.T.E.L users can set the numerical value.

Note: The maximum alarm value for mg/m³ is 500 mg/m³. If the user requires monitoring over 500mg/m³ then the ug/m³ unit of measurement must be selected. The HD-1620 will display the max value.

When sampling in ug/m³ the maximum concentration range is 500,000 ug/m³. Users cannot select over this.

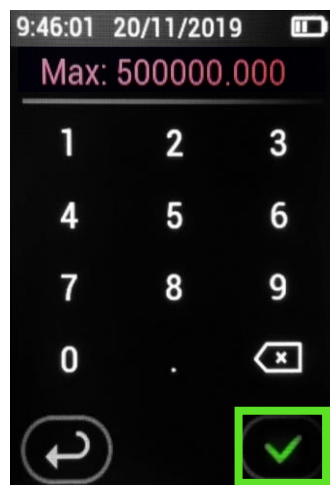
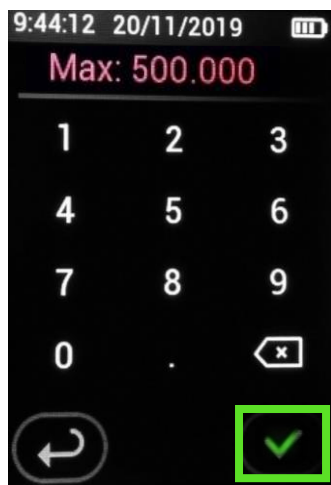

Note: Once the green checkmark is pressed, the Data Sample Settings menu reappears. The user must press the green arrow on this screen as well, or the changes will not be saved.

Once the alarm level is met or exceeded, LEDs on the LED bar will flash red, an audible noise will signal and a popup warning will appear.

The alarm will continue to beep and the pop-up warning will remain until the user has selected the green check mark. Once the check mark is selected the instrument will continue to sample.

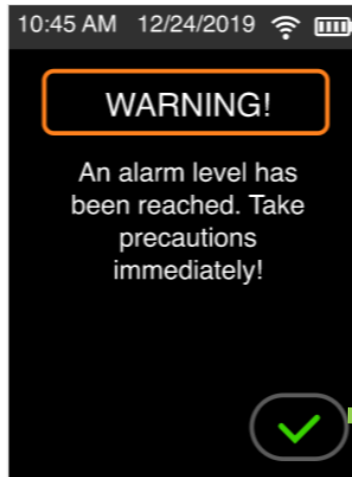

Press the green check mark to continue sampling and silence the alarm.

Once the audible noise has been turned off, the LED will turn green when the concentration dips below the alarm threshold and will flash red when the concentration meets or exceeds the alarm threshold but it will not continue to make an audible noise.

A red box will appear around the real-time parameters if the Ceiling Alarm is met. An orange box will appear if the STEL is met.

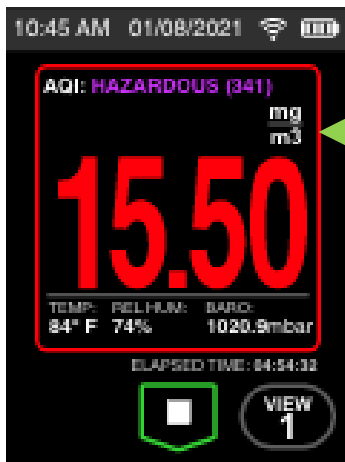

A **red** box will appear around the parameters to indicate the **ceiling** alarm has been met.

An **orange** box will appear around the parameters to indicate the **STEL** alarm has been met.

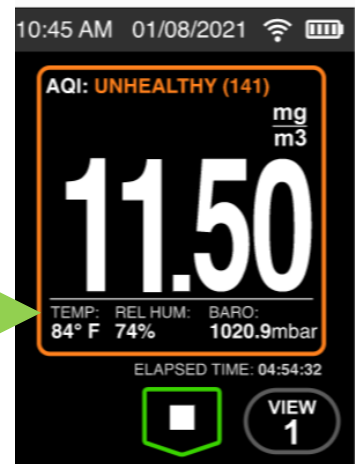

Pressing the alarms button will only turn off the audible alarm not the visual alarm. Set the alarm to zero to disengage the visual alarm.

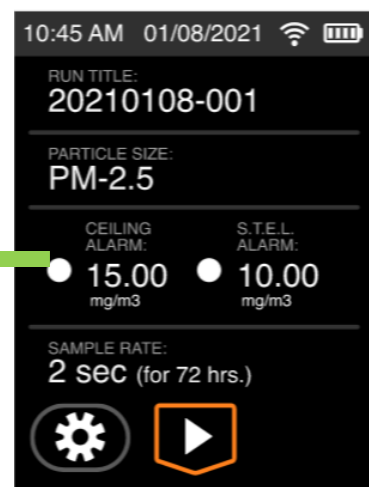

Once the sample is stopped the statistics screen appears. On the upper right corner of the display is a box labeled “events.” An event is considered something noteworthy for the data set. i.e., ceiling and STEL alarm threshold met or exceeded, a pump fault, low battery status or calibration span fault.

A numerical value will appear inside the box indicating the number of events for a given data set. When the event box is selected, a new screen will appear indicating the type of event. In the example below, the Ceiling Alarm and STEL alarm was met or exceeded.

NOTE: The event or fault will be downloadable and viewable in the software.

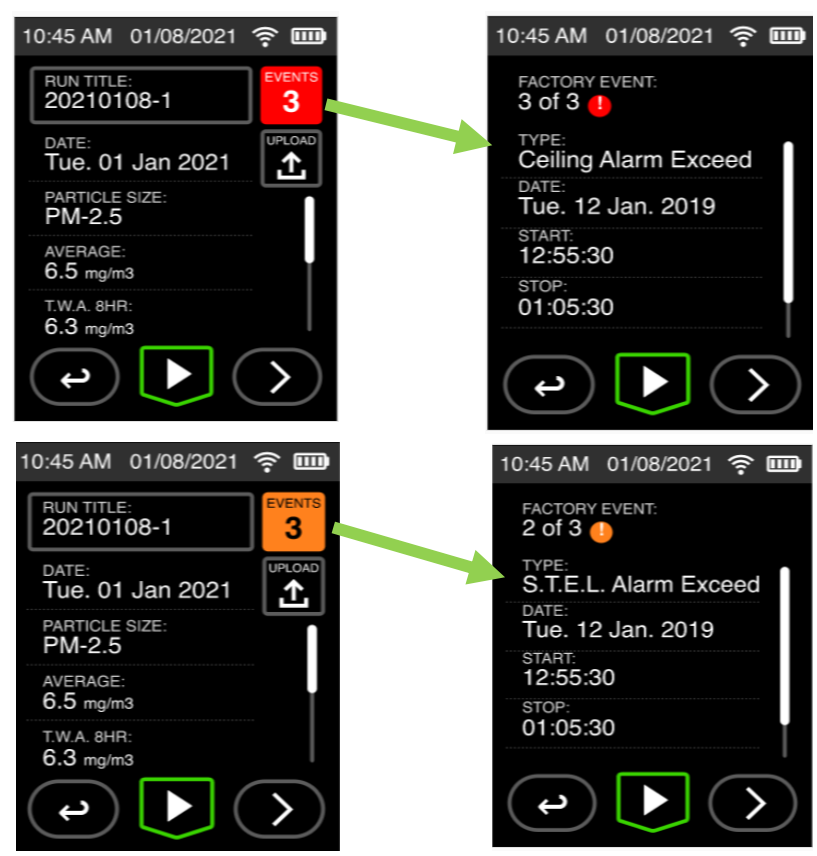

Setting Engineering Units of Measurement

Users can select either mg/m^3 or ug/m^3 or Particles/ cm^3

1. Press “Particle Size” on the “Data Sample Settings” menu.
2. Select the Edit (pen) icon.
3. Then select “units.”
4. Once the user preference is selected press the Green Check Mark or else the selection will not be entered.

Note: Only one unit of measurement will be visible at a time. Users can toggle between ug/m^3 and mg/m^3 .

The only way to deselect PM/ cm^3 is to press the radio button to deselect; pressing mg/m^3 or ug/m^3 will not deselect PM/ cm^3 .



The particles/ cm^3 measurement represents the Particle number or PM count within the selected size fraction dictated by the impactor being used.

NOTE: If PM/ CM^3 is selected the alarm will **not** trigger.

DELAYED START/ PROGRAMABLE START STOP.

1. First, make sure time format and time is set.

NOTE: The delayed start ONLY works on a 12-hour time format.

2. In the settings menu scroll down and select “Delayed Start”
3. Press enable delayed start.
4. Press on the “Start Time” and enter desired selection. Press check mark to confirm selection.
5. Press “Duration” and enter the desired run time duration. Press the check mark to confirm.

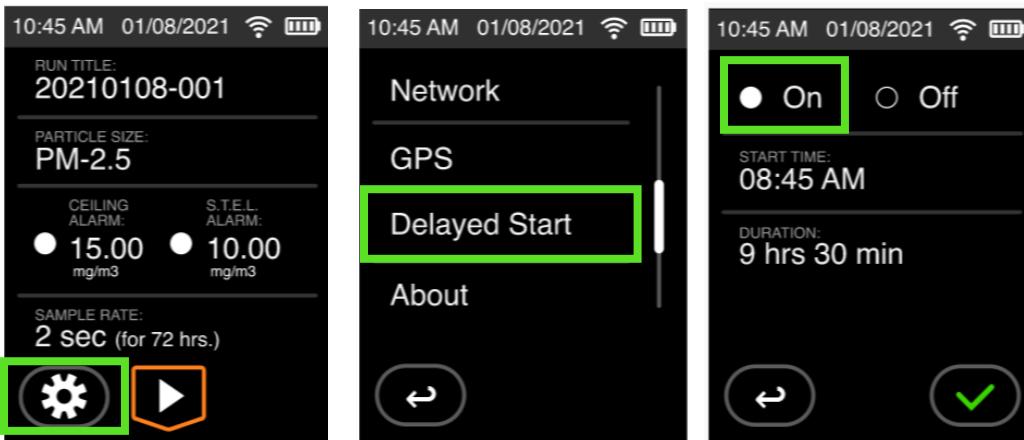

When the delayed start is set the instrument will enter a dimmed screen mode to preserve battery life. The instrument should not be powered down while waiting for the delayed start time. The HD-1620 will automatically start and stop upon the set time and duration.

Setting Log Rate & Memory

Selecting Log Rate:

From the Data Sample Settings Menu select “Log Rate” Select the desired rate. Stated after each option is the approximate memory available for each desired selection.

1 Second ~ 12 hour

4 seconds ~ 25 hours

10 seconds ~ 60 hours

60 seconds ~ 15 days

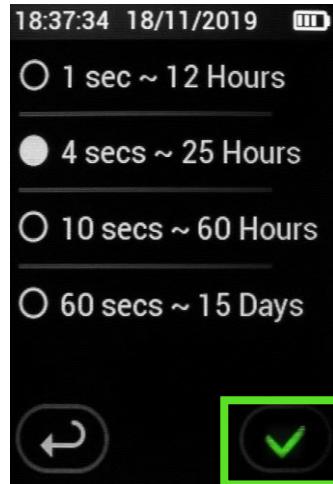

Note: When the data storage memory is low, a message will appear. The user will be presented with dialog messages and options on how to proceed when memory is low. Users can stop sampling, continue to sample, overwrite data or upload data.

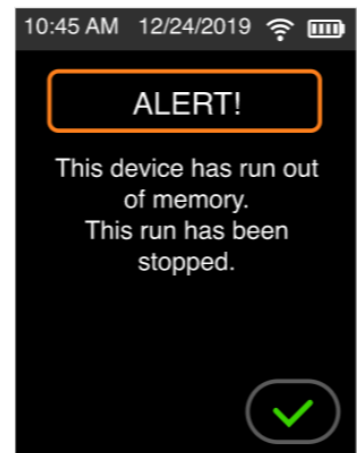
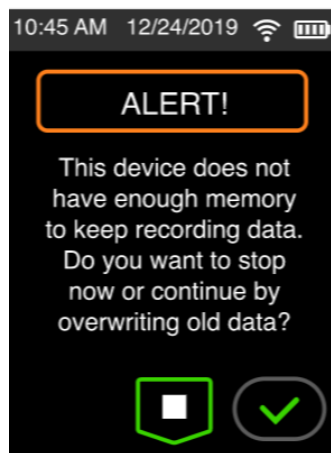
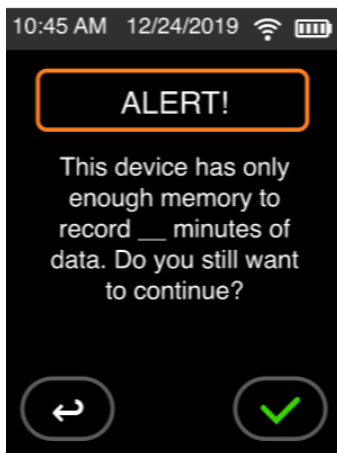

Cross Calibration

Introduction

The HD-1620 allows users the ability to enter a Cross Calibration Factor. Real Time Nephelometers are calibrated with a standardized test dust. Test dust can vary; however, a commonly used test dust is ISO12103-01A2 Fine Test Dust, or “Arizona Road Dust.” The particle characteristics and properties of aerosol at the application site, will vary from the test dust, causing a variance in the instrumentation response. To compensate for this variance a Cross Calibration is required to derive the Calibration Factor also commonly called the Scale Factor.

$$\text{Calibration Factor} = \frac{\text{Gravimetric Filter TWA}}{\text{HD-7204 TWA}}$$

Cross Calibration typically requires two devices; a Reference Sampler and a Real-Time Nephelometer (*The HAZ-DUST Model HD-7204 personal monitor is reference sampler and offers real-time readings*). The reference sampler offers a flow compensated pump with a filter option. The filter is sent to the lab and compared with the ex post facto real-time readings. See example below.

Filter TWA result divided by HD-1620 TWA result

EXAMPLE:

Filter TWA was 5 mg/m³
HD-1620 TWA was 2.5 mg/m³

$$\frac{5}{2.5} = 2.00$$

The Scale Factor to be entered for the next sample under the same conditions is 2.00

To enter a Calibration Scale Factor:

By utilizing the “Data Sample Settings Menu”

1. press “Particle Size”
2. then press “Cal Factor”
3. Enter the Calibration Factor
4. Press the green check mark or the selection will not be set.

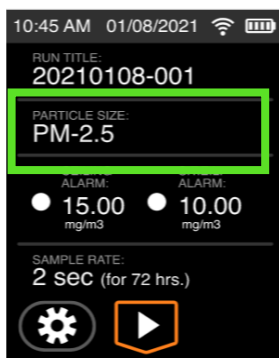

Selecting Language

Introduction

The language is pre-set to English. It may be necessary to change the language based on the country of ultimate destination and or user preference.

Selecting Language

1. From the Home Page select the settings icon. Scroll down until you see the “Language” Option. Select desired language. (The language options are English, French, German, Spanish, and Chinese.) Press the green check mark to save or press the back button to exit without saving changes.

Note: When language is selected the following menu screens will change: Setting options, the titles on the home screen. The keyboard entry will always be English alphabet.

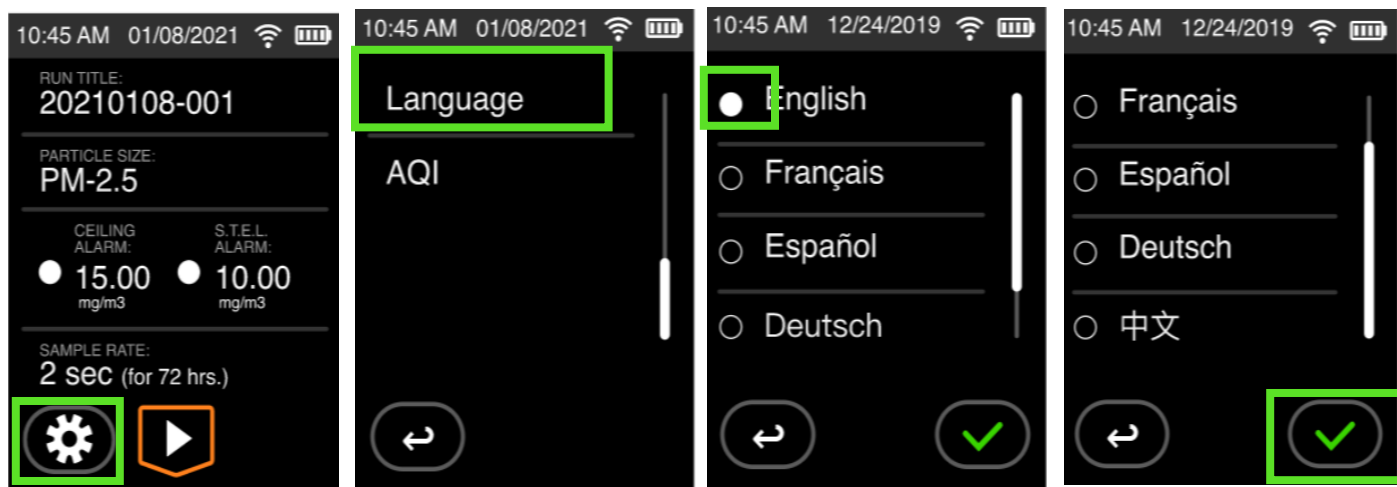

Setting Date and Time

Introduction

The date and time is pre-set by the manufacturer, Environmental Devices Corporation to Eastern Standard Time. It may be necessary to change the date and time due to local time zones, daylight savings time or as preferred for a specific geographical location.

Note: It is important that the system date and time are correct for accurate record keeping and for the programable start/stop to work.

Date and Time settings

The HD-1620 offers two-time formats; a 12- hour setting and a 24-hour (military) option. Factory default is a 12-hour setting.

The HD-1620 offers three date formats;

MM/DD/YYYY

YYYY/MM/DD

DD/MM/YYYY

Factory default is MM/DD/YYYY

Change Date and Time format

1. From the Home Screen Select “Settings” Icon. Then Select Date “System Formats”

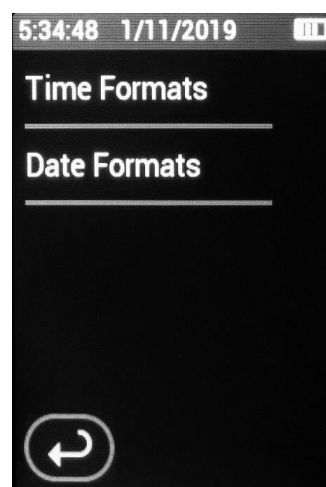
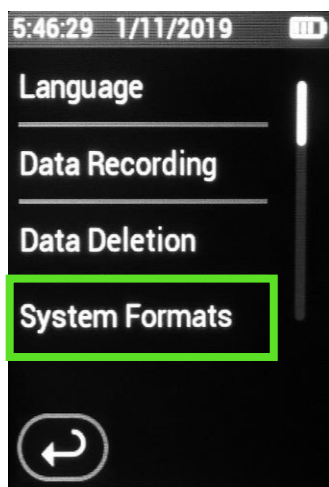

2. Next select “Time Formats and/or Date Formats”
3. Select the desired option and press the green check mark to save or press the back button to exit without saving changes.

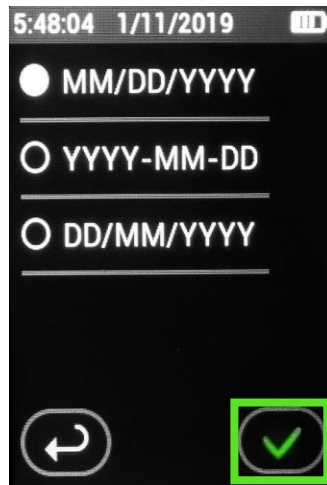
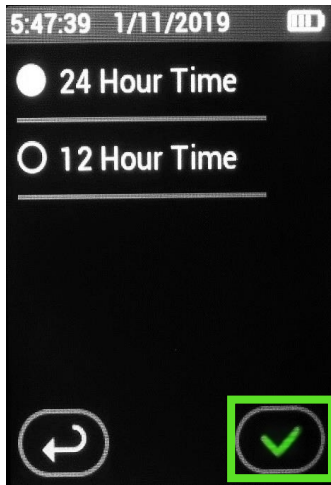

Setting Date and Time

1. From the Home Screen Select “Settings” Icon. Then scroll down and select Date and/or Time.

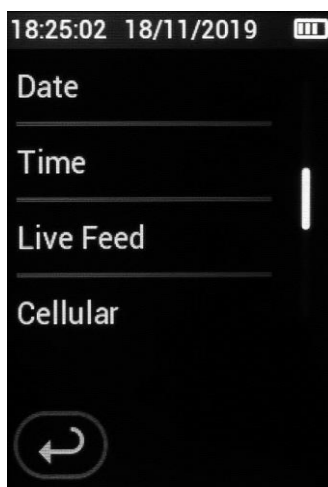
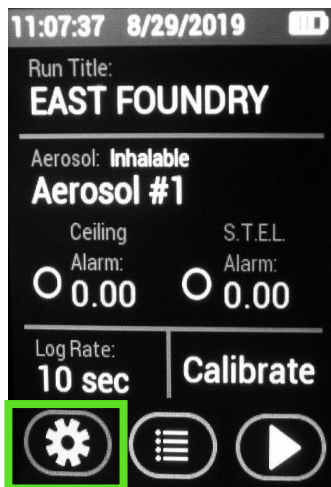

2. Select the desired option and press the green check mark to save or press the back button to exit without saving changes. The change will be viewable on the information bar at the top of the Touch Screen.

Data Recording

Introduction

Each data set can either be saved (preserved) or erased and rerecorded with each new data set.

Data Recording Options

1. From the “Settings” menu press “Data Recording”
2. A dialogue box will appear and ask users to confirm continuation.
3. Select either “Preserve Logs” or “Overwrite.” By selecting Preserve logs each data set will be saved.
4. Press the green check mark to save or press the back button to exit without saving changes.

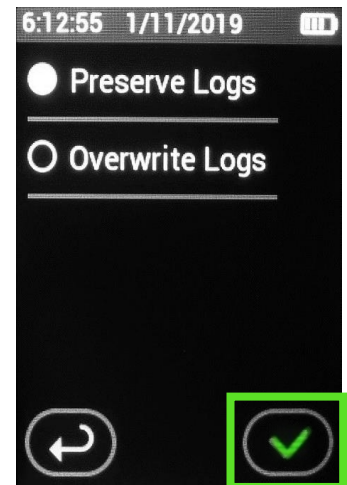
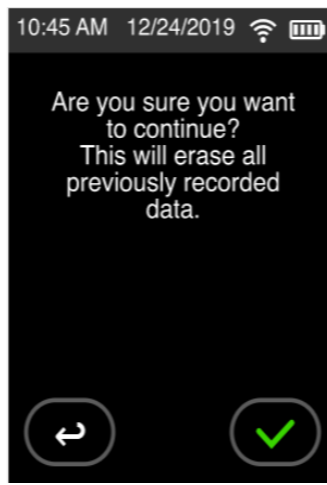
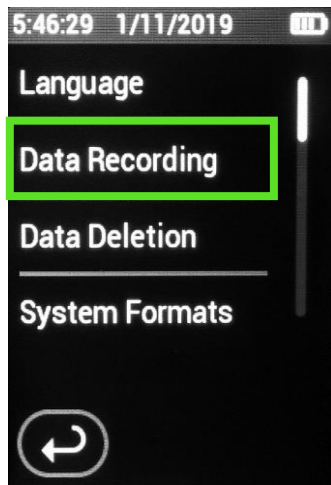
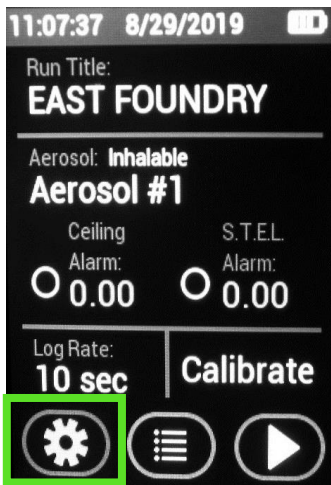

Data Management

Introduction

The memory of the HD-1620 can be cleared at any time. There are several options for erasing data. Data Deletion erases all previously recorded data sets while maintaining Run Titles and other unique customer entries.

Data Deletion

1. From the Home Screen Select “Settings” Icon. Then click “Data Deletion.”

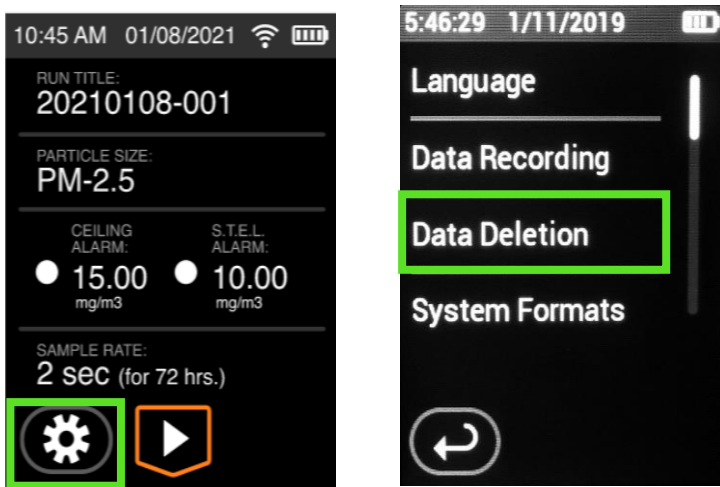

2. The HD-1620 will then prompt for confirmation. Click the green check mark to confirm and erase all data sets. Click the back button to exit without deleting any data sets. When complete the History Screen will be empty as shown in the last picture.

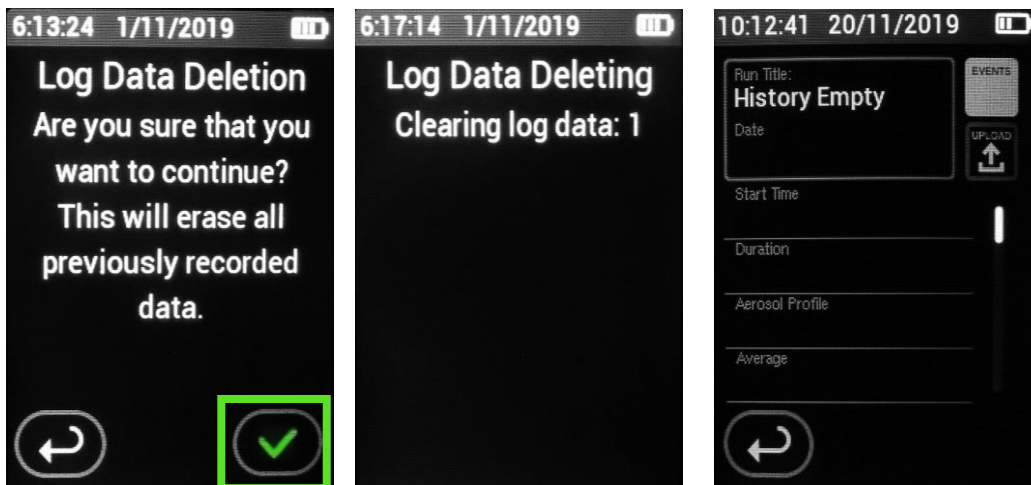

Clear Run

Clearing the run will erase all the data sets similar to performing a Data Deletion. The difference is Clearing the Run will also delete customers unique entries like Run Title, and Calibration Spans. Think of the Clear Run function as a factory default.

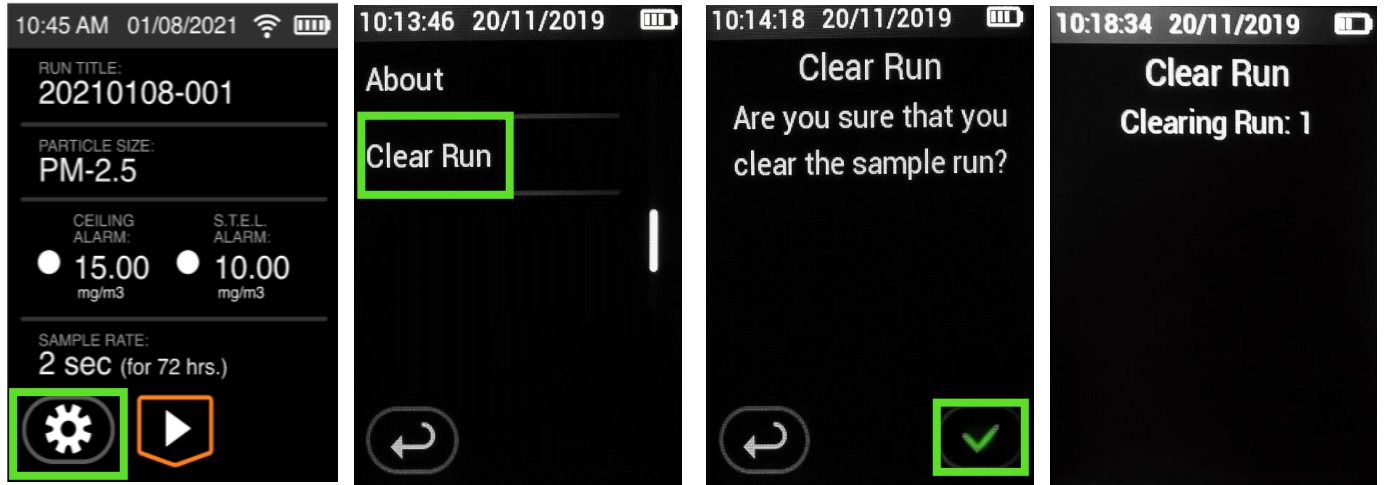

Overwriting Data Sets

From the Home Screen Select “Settings” Icon. Then select “Data Recording”. Next select “Overwrite Logs.” When “Overwrite Logs” is selected each new data set will clear the last by overwriting.

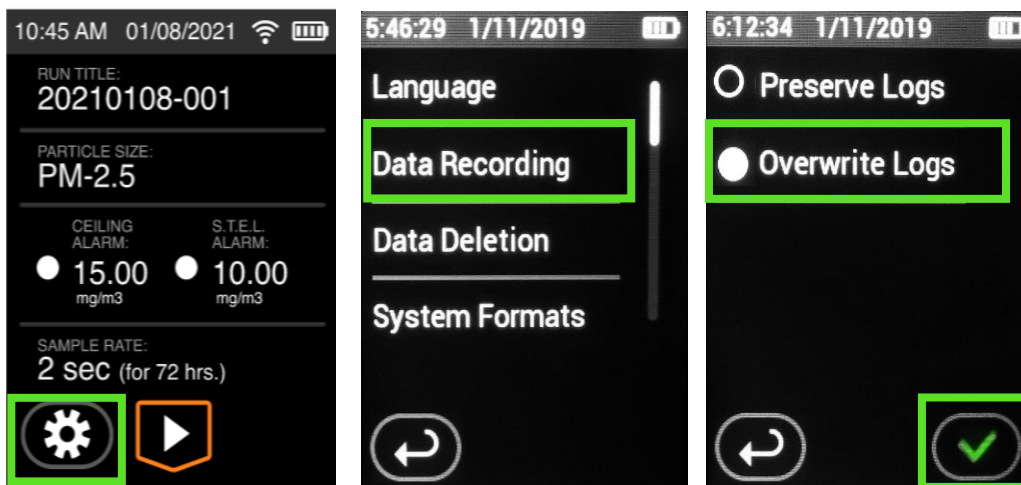

About & Maintenance Screen

Introduction

The About Screen states useful information about that particular instrument for the technician and the user.

- Manufacturer (EDC)
- Model HD-1620
- Firmware version
- Serial Number
- Operation Hours
- Battery life remaining
- Last Calibration Date.

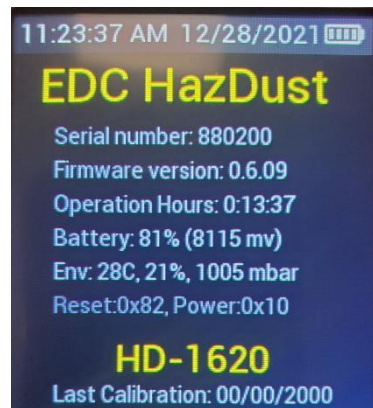

The User Maintenance Screen is a useful tool when used properly. The User Maintenance Screen was designed for the user. The is screen allows the user to keep track of service. For example, if the user would like to replace the internal filters after 500 hours of run time or send back to the factory for service, this screen will allow users to verify the run time of the instrument. Once the service is complete, the user can edit by pressing the pen icon. A dialogue message will appear asking the user to confirm selection.

Once the green check is mark is selected, the Maintenance Screen will reset itself. Once reset, the 'Last Maintenance' will change to the day the reset was performed, the 'Run Time' will read 0 hrs., 0min and the 'time until next maintenance' will reset to 500hrs, 00min. Once reset, there is no way to reverse the change.

NOTE: Resetting the User Maintenance Screen does not change the operation time on the About Screen.

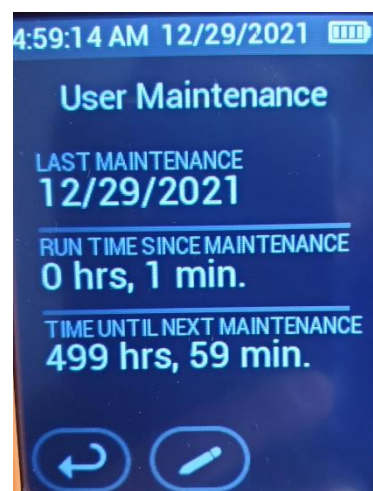

Battery Maintenance

Notes and Cautions

Instrument will not sample if the battery status is low.

- Do not operate pump from or charge pump in hazardous locations.
- Power off pump before removing battery to avoid loss of time, date, and other settings.
- Use only the EDC approved battery pack (P/N BP-1620) an unapproved battery and/or could damage the pump and will void any warranty.
- Tampering with the battery pack (opening, disassembling, short circuiting, crushing, or exposing the battery pack to temperatures in excess of 212 F [100 C]) voids any warranty.
- User may replace external components such as the inlet filter, battery, and/or belt clip. Warranty is void if the instrument is opened by user.
- Failure to follow warnings, notes, and cautions voids any warranty.
- CAUTION: The battery used in this device may present a risk of fire or explosion when heated above 212 F (100 C) or incinerated.
- Warning: To prevent ignition of a hazardous atmosphere, batteries must only be changed [removed and replaced] in an area known to be known-hazardous.
- CAUTION: Risk of Fire and Burns. Do Not Disassemble, heat above 212 F (100 C), or incinerate. Keep battery out of reach of children and in original package until ready to use. Dispose of used batteries promptly according to [all state and] local recycling or waste regulations.

Note: To conserve battery power, the instrument will enter an idle state after 20 minutes of inactivity.

Determining Battery Charge Status

The battery status icon at the top right of the Home Screen contains four bars that reduce in number as battery charge is depleted. Use the table below to interpret the battery status icon.

Icon Displayed Battery Charge Remaining



Four Bars = Full battery charge 75%-100%



Three Bars= Approximately 50-75%



Two Bars= Approximately 25-50%



Zero Bars= The instrument will enter low battery status and register as a fault. The instrument will eventually shut off. The data will be saved until the instrument stops working. An event will be registered on the data history.

Charging the Battery

Charge the battery under the following conditions using only the supplied and or approved EDC charger.

Note: a fully charged new battery will last 20 hours at 1.5 LPM at 70F (21 C).

1. Upon receipt of purchase or service and calibration.
2. The instrument should be charged whenever the status dips below 50% to avoid the instrument shutting off during a sample run.
3. The instrument should be charged every two months when in storage.
4. Whenever being stored in temperatures over 70 F (21 C) or higher as higher temperatures increase the rate of discharge.

Replacing the Battery

Introduction: Periodically, the battery will need to be replaced. The battery is located in the handle of the instrument and is attached by one white plastic connectors and very strong tape.

1. Turn instrument off.
2. Remove the back cover of the instrument by removing the 6 screws.
3. Pull up on the white connector. This will pull out with ease and there is no tab to push in, simply pull up. Do not touch the black connector as that is not connected to the battery.
4. Rock the battery back and forth. The battery is in place with a very strong adhesive so a little force maybe needed.
5. Purchase new adhesive if required and replace, otherwise, swap the battery.
6. Plug in the white connector. When plugged in the instrument will turn on.
7. Ensure the charge jack did not move and is still seating properly before scewing down the back housing.

Step 1. Pull up on the white connector. (*Do not touch the black connector*).

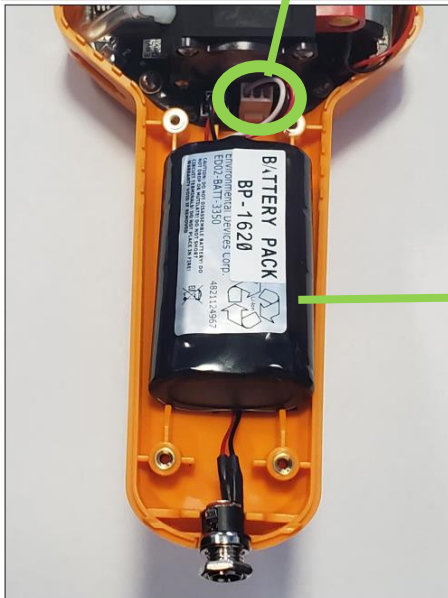

Step 2. Rock battery back and forth to free from adhesive.

Cleaning Sensor Optics

Description:

A dirty optical sensor can affect the readings of the instrument and should be cleaned periodically. **Note:** Cleaning should be performed after every 8.0 hours of use when monitoring in average concentrations of over 1 mg/m³.

- Step 1.** Remove the 6 screws on the back of the housing. Then remove the screws holding the sensor shield to the optical sensor. See drawing below.
- Step 2.** Observe optical sensor for residue/dust. Using bulb, blow off any residue/dust inside the optical shield and on the optical sensor. Then clean the optical lens with a foam tip swab. **DO NOT** use a cotton swab it will scratch the lens and void warranty.



Figure 4. P/N KKB-101

NOTE: Do not use liquid cleaning solution. Excessive cleaning will damage optical paint & penetrate behind optical lenses and will void warranty.

- Step 3.** If Cleaning Kit is purchased, use the provided moistened wipe to gently clean external optical sensor and instrument if needed. Contact EDC if you did not purchase a cleaning kit.
- Step 4.** Replace optical shield and screws.
- Step 5.** Re-zero instrument.

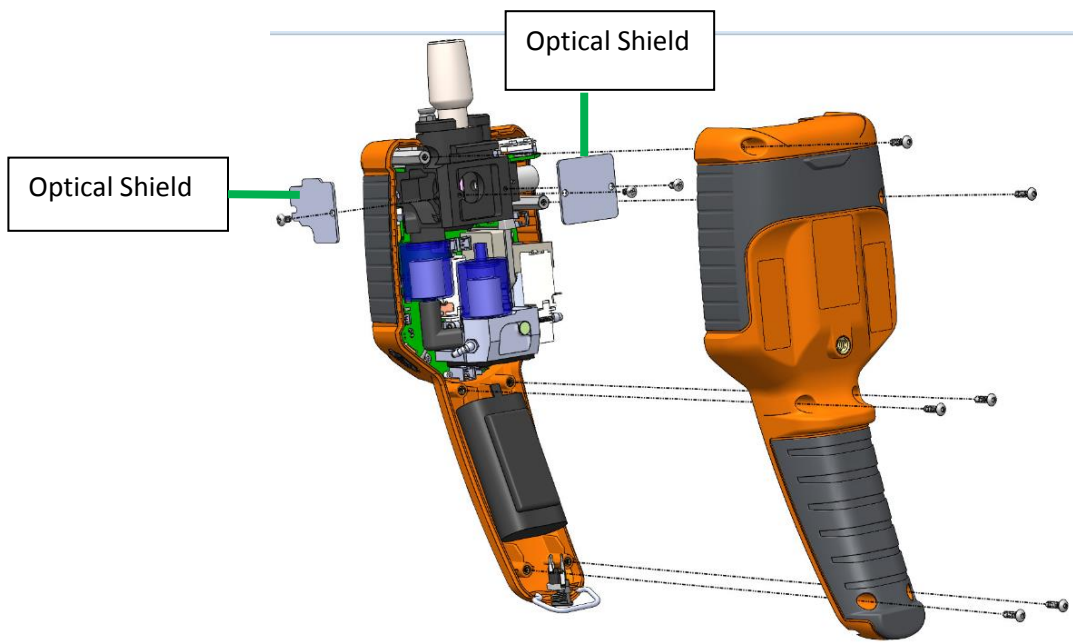

Flow Rate

Calibrating Flow Rate

1. Insert impactor size of choice.
2. Turn on the instrument.
3. Ensure the instrument recognizes the proper impactor is inserted.
4. Attached the provided flow adapter. The compression fitting fits snugly into the impactor Air Intake. If the seal is not a snug fitting, maintain pressure by gently pushing down on the Air Intake while adjusting the flow.
5. Attach tubing to the flow meter of choice.
6. To calibrate flow, select “Pump Flow” from the settings menu.
7. Use and the plus or minus icons to adjust flow.

Note: Using the plus and minus buttons on the HD-1602's display will not change the target reading on the HD-1620. Pressing the +/- will only change the actual flow displayed on the flow meter.

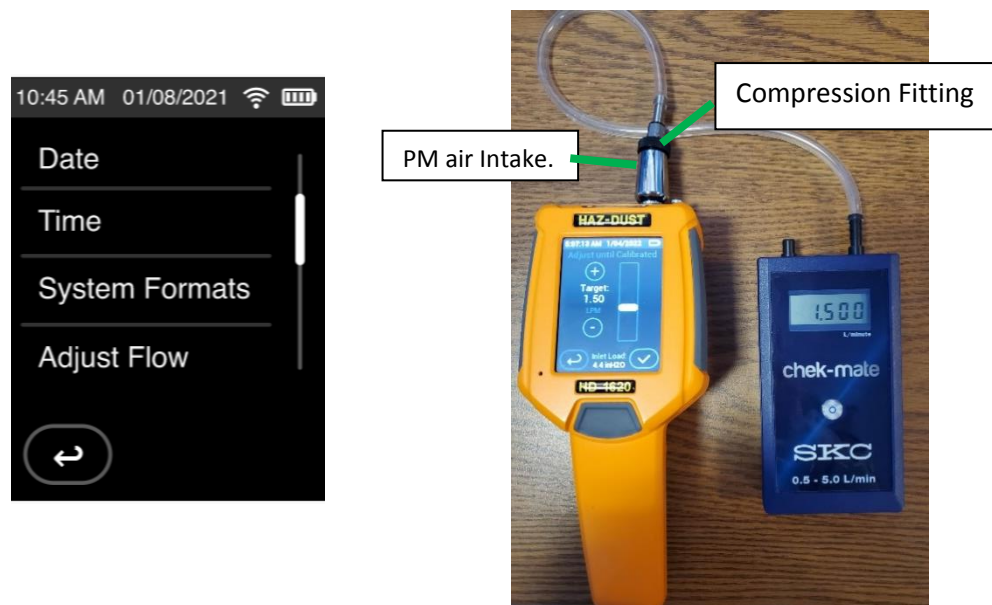

Faults

Introduction

The HD-1620 will fault if the pump is not working properly, battery is low or an alarm has been met.

Flow Faults

The pump will fault if there is kinked tubing or overloaded sample and can no longer sample with +/- 5% pump. If the event is sustained for 3-10 seconds pump will enter flow fault mode and Stop running. The Lights flash pinkish purple.

After 20 seconds the pump will attempt to restart 5 times.
If pump restored during the 5 attempts, then sample as usual.
If pump doesn't restore within 5 minutes the pump will end the sample.

Alarm Fault

When the alarm is met or exceeded the lights will flash red or orange depending on the alarm. See section on alarms.

Battery Fault

The lights will flash red when the battery status is low.

Note: When viewing history, the faults will be indicated for each date set as a numerical value listed under "Events." When pressing "Events" users will see an expanded view and the fault or event will be listed under "Type". In the example below the first of three faults was that the run had stopped. The second of three was the STEL alarm was exceeded.

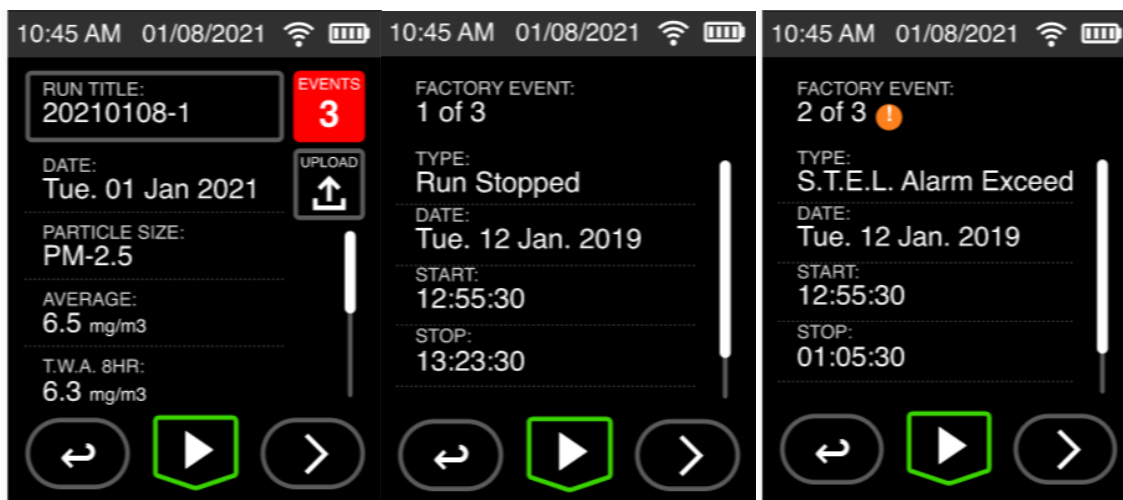

Reviewing Stored Data

Introduction

The HD-1620 provides the user to view sample run statistics contained within individual data sets.

How to Review Stored Data

1. From the Main Menu Press the Setting icon. Scroll through the menu until you see “Review Data” Press this option.
2. Next to the Run Title is a number. The number displayed represents the number of the data sets. When pressing the left arrow, the number will decrease to represent the last data set taken.
3. To view all statistics of a data set, use the scroll bar.
4. Any faults are listed as “events” Press events to see an expanded view of what faults transpired during a data set.

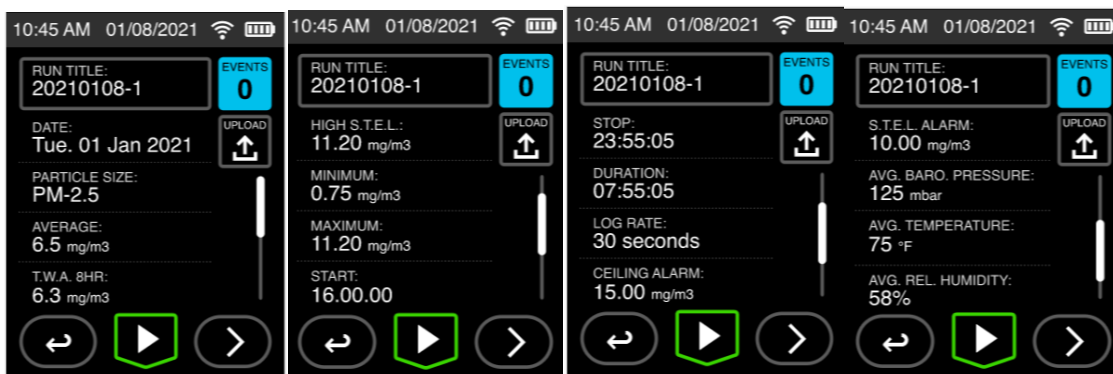

Uploading Data

Introduction

In order to upload Data, the HD-1620 must be connected to a computer using the Micro USB provided. The data will upload from the instrument to the HAZCOMM Pro Software. The upload will only work on Windows 10. It is not supported on earlier versions on Windows.

See Software Manual for a detailed description on how to upload data.

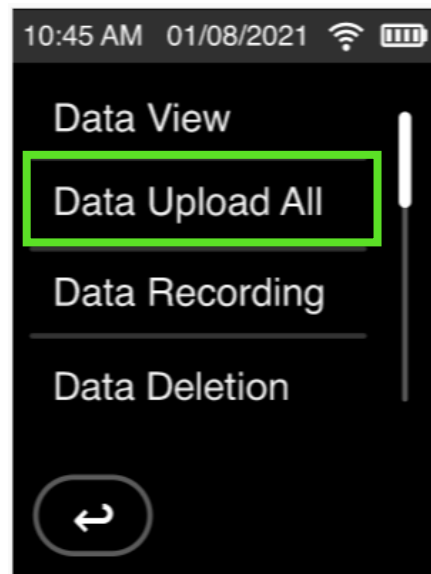
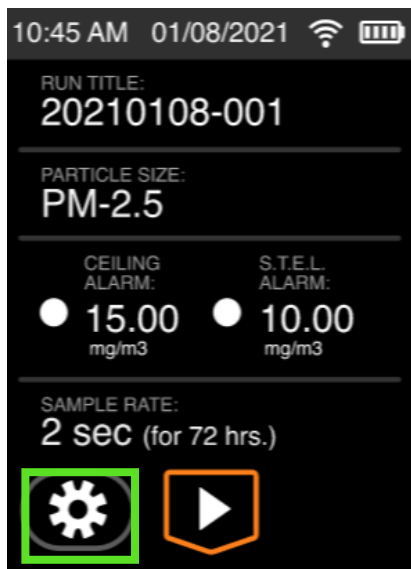

Introduction

The HD-1620 offers a live feed option. This option will allow users to graph and see real-time concentration values and graphing on a PC. This feature requires the device to be hardwired to a PC or laptop unless wireless options were purchased with the instrument.

Note: In order to download the live feed data must be turned off.

Setting Up Live Feed

1. From the Home Screen Select “Settings” Icon. Then select “Live Feed”. Next select “Live Data USB.” Use this option if you do not have wireless configured on your instrument or the first time trying the live feed feature.

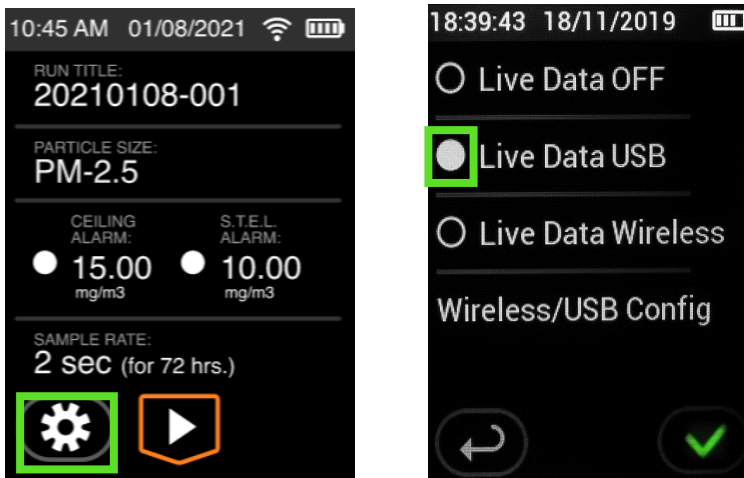

2. If any wireless options were purchased select “Live Data Wireless.” See Section for Wireless Live Feed to configure the live feed.

Note: See Software Manual for a detailed description on how to utilize the live feed feature.

DustComm Pro Software –

To upload data from the instrument to the PC

Turn on the instrument and computer.

From the settings menu on the instrument (see Operator Instruction Manual for the HD-1620) Locate “Live Feed” select “Live Feed Data off”

Plug in supplied download cable to the instrument.

Then from the setting menu on the HD-1620 press “Data Upload All.”

Open the software. Do not open software before this step.

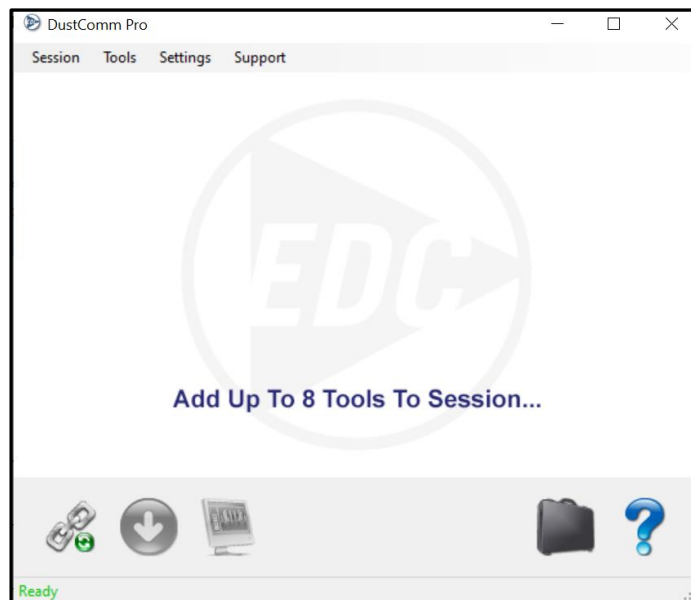

Under the “Settings” Pull Down Select “Port Preferences”

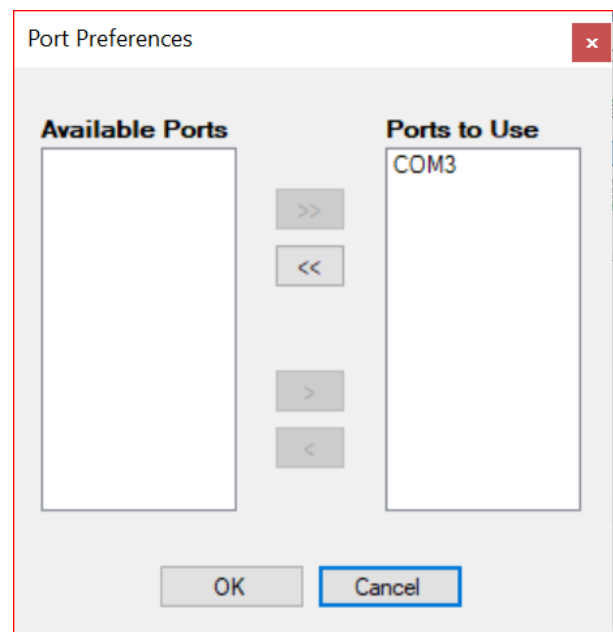
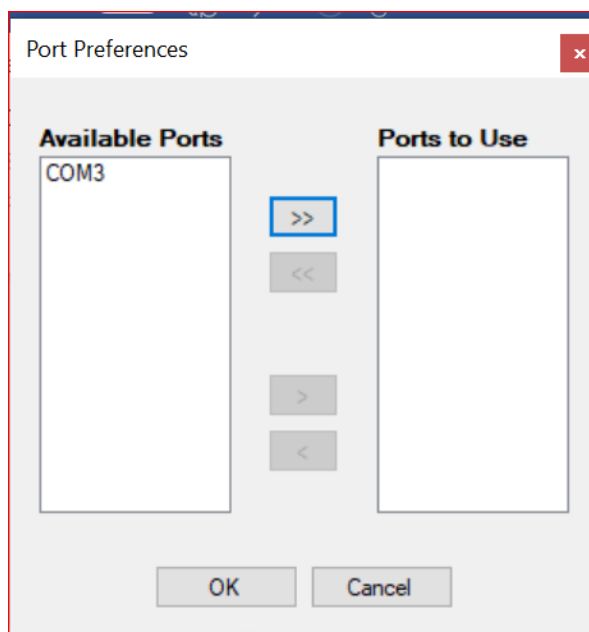

Select the correct Comm Port from the list of “available ports” Press the arrow to move the port into the “Ports to Use column.”

Press ok.

Press the Chain Icon on the bottom left. This enables the software to connect to the instrument.

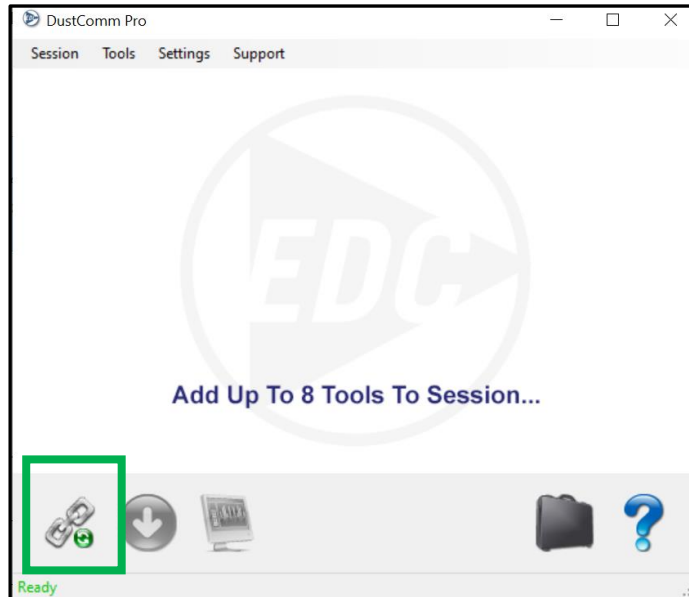

The instrument should appear and will be automatically identified by the serial number. If the instrument has already been put into a Tool Bag and given a unique name and description, then next time the instrument is plugged in, the serial number will not be present but the previously entered information will be viewable. See example below.

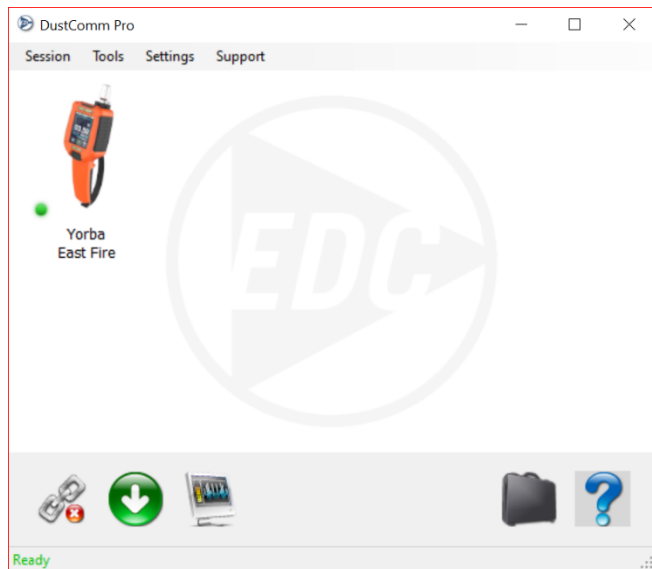
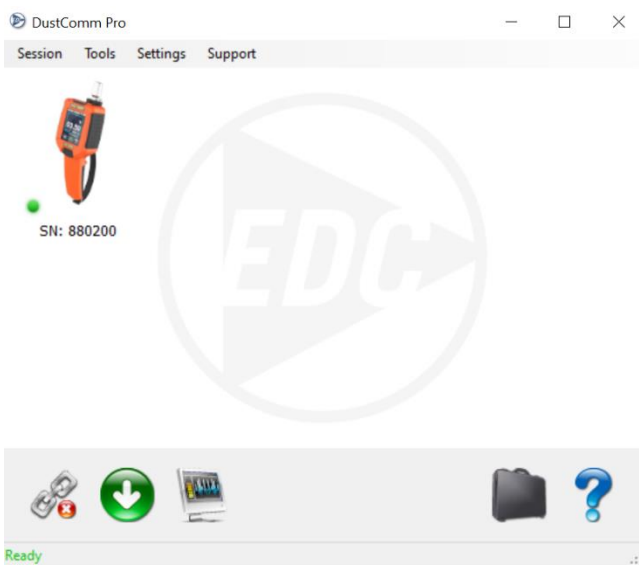

Next, press the green down arrow on the software. The software will now download all data sets in the instrument.

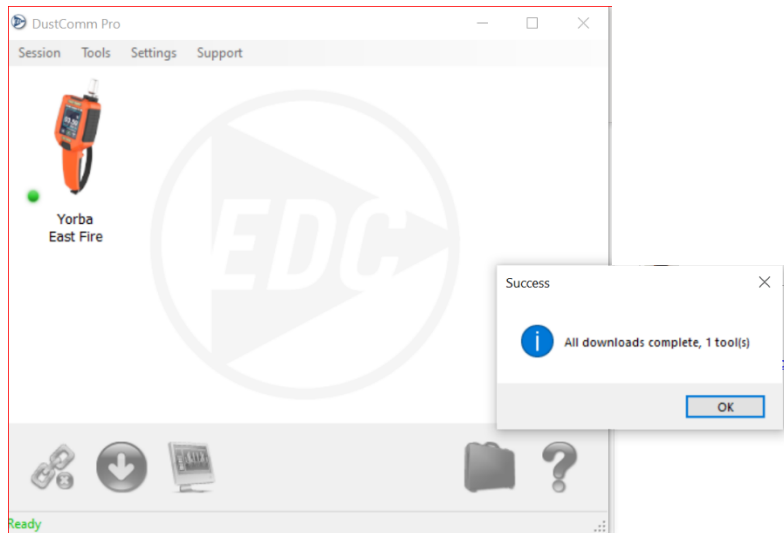

Once the data has been uploaded to the software a Dialog box will appear stating “All downloads complete, 1 tool.” If downloading within a network the ‘1 tool’ will state the number in the network.

To view the data right click on the instrument and select “View Data.”

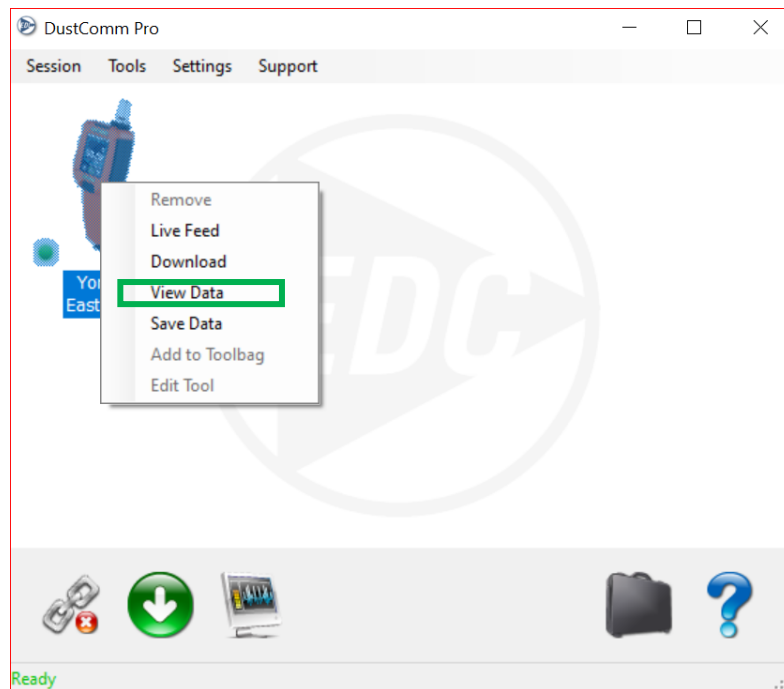

A new window will appear with the newly downloaded data.

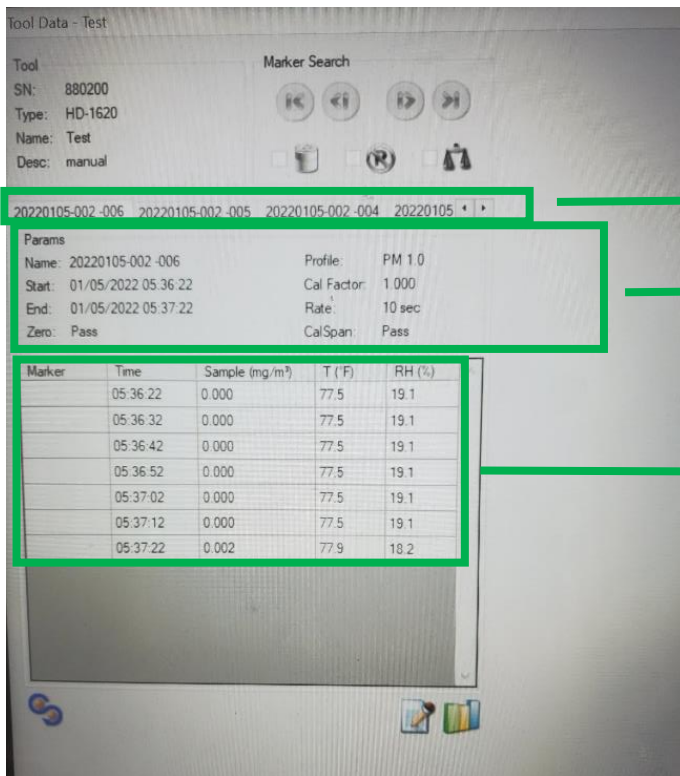

A new tab will appear for each data set.

Statistics pertaining to the open data set

Individual data points within a given data set.

If a user would like to graph more than one data set at a time this can be done by using the Group Feature. To use this feature click on the “S” like shape on the bottom left of the screen.

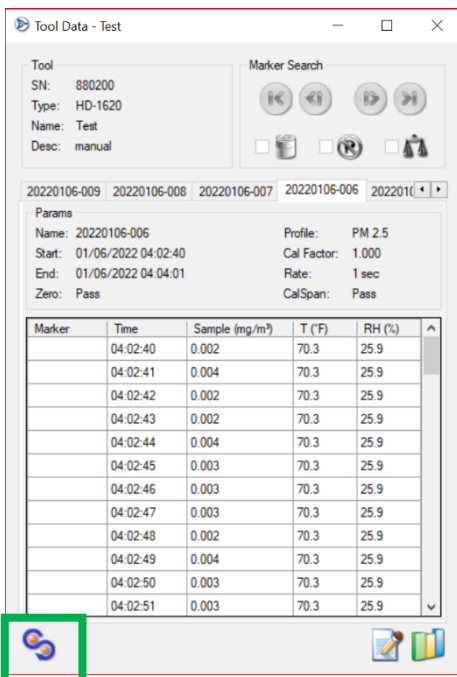

Press the Group Icon

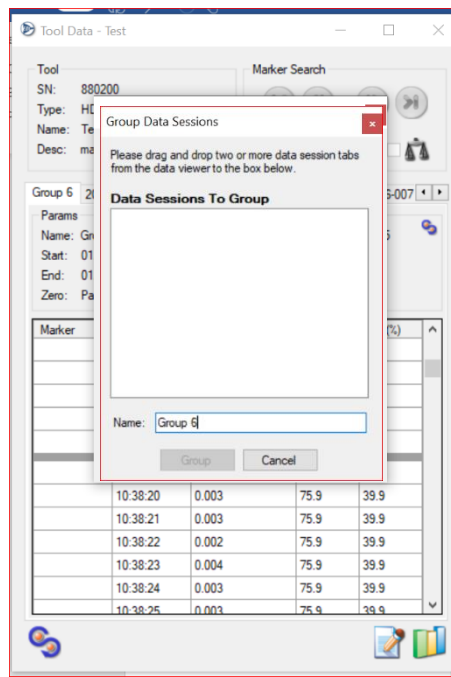

A dialog box will appear. Grab a data set tab and drag and drop into the dialog box. Name the group.

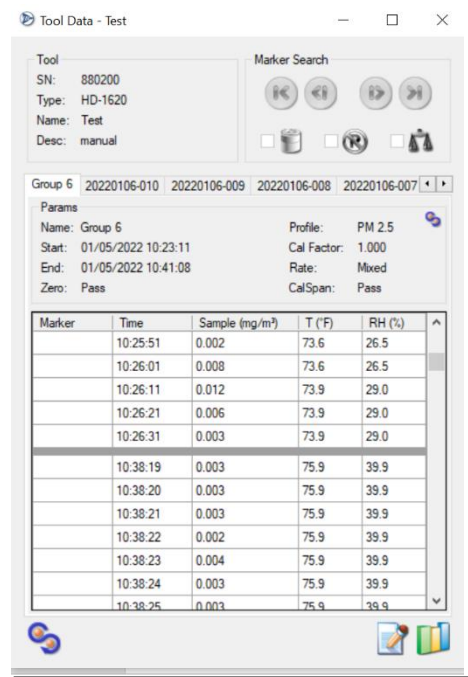

The new grouping will now show on the tab and the data sets will be separated by a thick line.

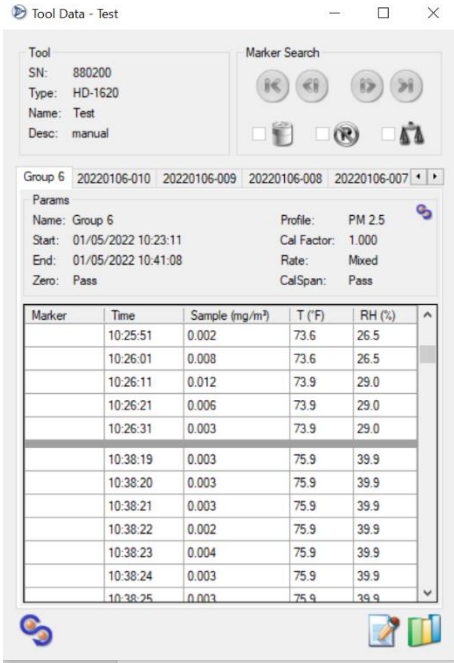

After a data set has been grouped, the Group Icon appears. To ungroup a data set, press the icon and a dialog message will appear asking for conformation.

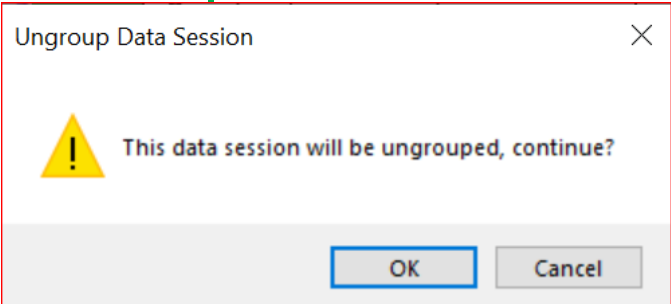

Once the data set has been ungrouped, it will be removed from the Data Set tabs.

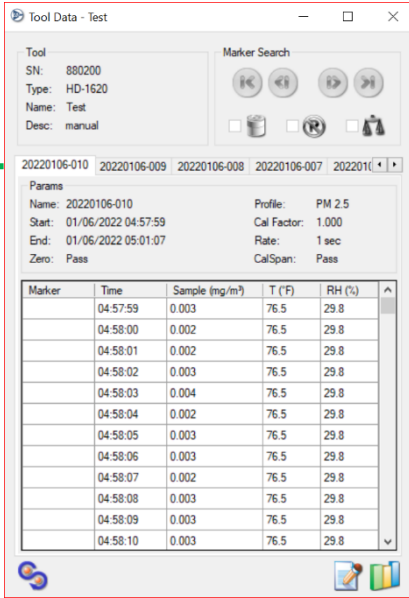

Opening Saved Data

To Open an already saved data file.

Click “Session” then click “Open”

The file must be a .dcs file extension.

Next under the Tool Drop down select “Load Data.”

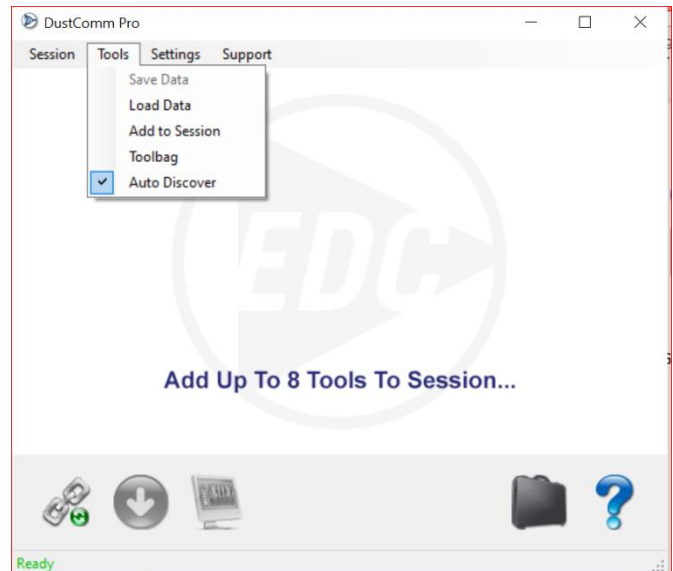
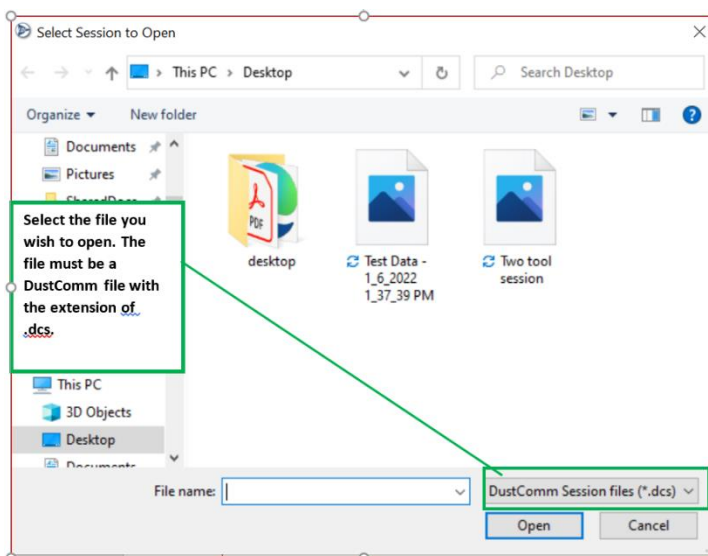
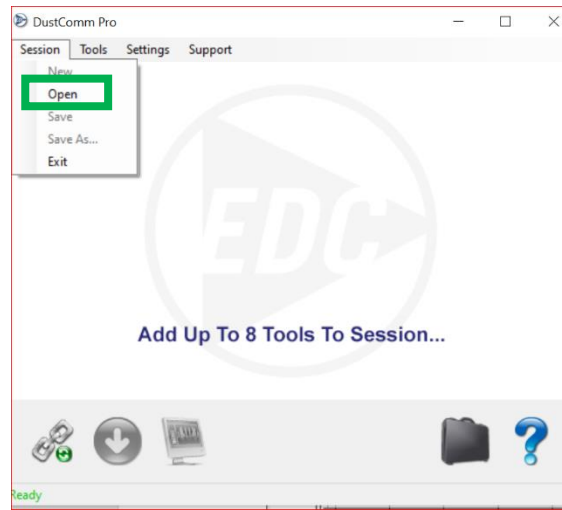

The data to be loaded must be a .dtd file extension.

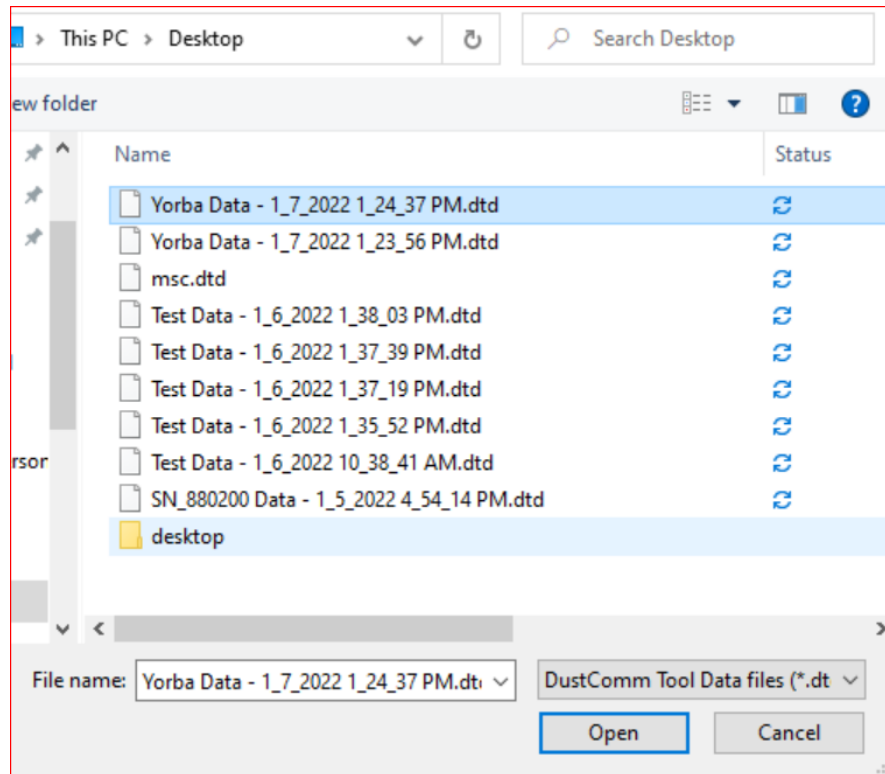

Now Right click the instrument and select "View Data."

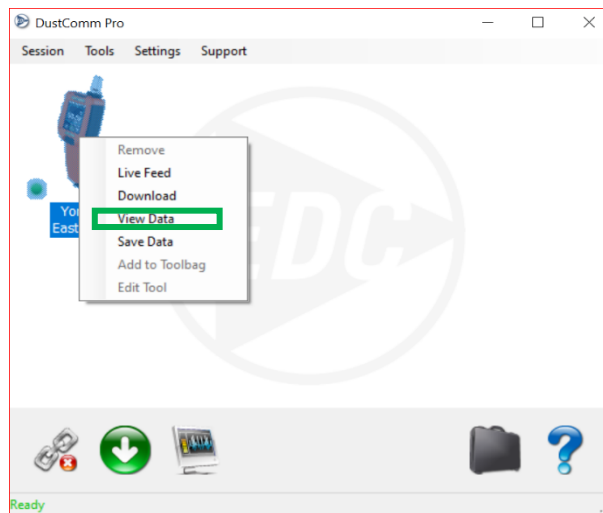

Tool Bag

An instrument is referred to as a tool. A session is collection of data. The user can have 8 tools of interment in a session. These instruments can be networked with the purchase of wireless configuration or added to a session individually. For example, let's say there was a forest fire that was recently put out. The Fire Department has deployed 4 employees, all with their own HD-1620. The employees are walking the parameter the of the of the fire. Each employee is assigned a quadrant; North, South, West, East.

The Session could be named after the fire: Town Woods Fire.

The tools can be given a unique descriptive qualifier. When the data is loaded and the instrument is right clicked there will be an option to "edit tool." Now, when you open that session or that tool you know detailed information about the data set.

Also buy click on the suitcase icon the user will be brought to the suitcase/tool bag (number of instruments in the tool case). Below we have two instruments. One instrument was at a school monitoring Air Quality in a class room. The other instrument was on the East Side of the fire.

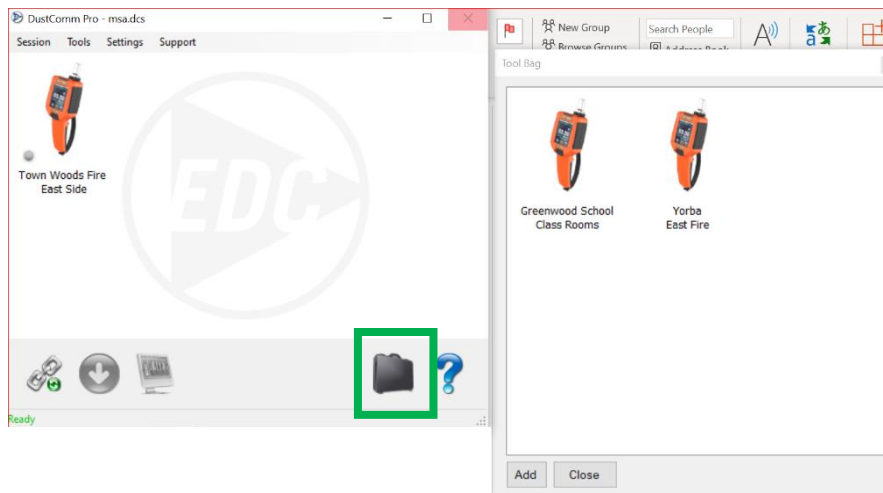
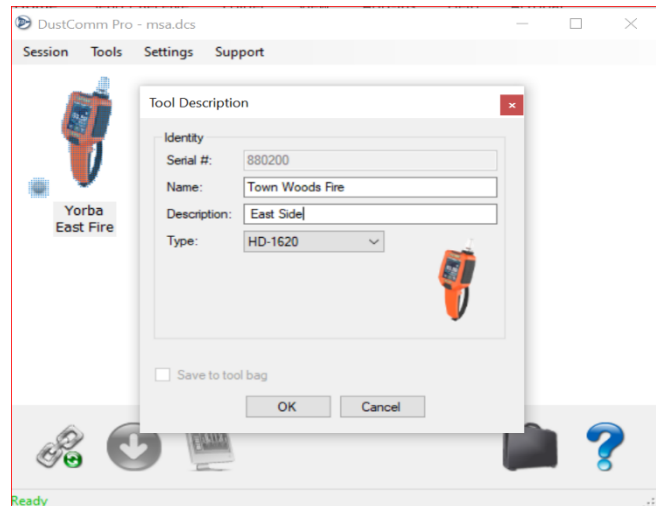
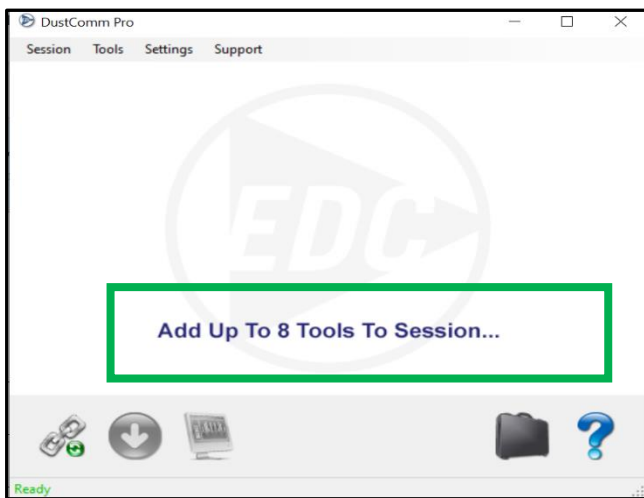

Live Feed

USING LIVE FEED OPTION

From the settings menu on the HD-1620 (see Operators Instruction Manual) Select “Live Feed” Then select “Live Data USB.”

After following instructions for establishing a connection from the software to the instrument, right click the instrument then click “Live Feed.”

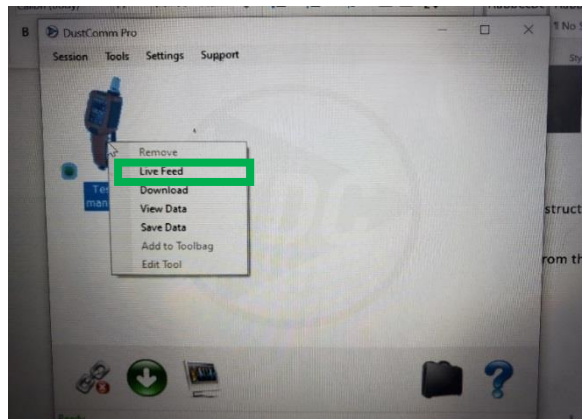

A new window will appear with the Live Feed data which contains a rolling graph for PM concentration in blue, Temperature in Green and Relative Humidity in Red.

All other statistical information will also be present such as
Serial Number
Model

And any unique qualifiers entered about the instrument. In this case, we have named this “Test” and the Description for ‘Test’ is Manual.

Next, is Pump information including, flow, temperature, and pressure. Listed below is atmospheric pressure and in the right column is the PM impactor that was used during sample, the Calibration Factor, Log Rate, and an indication if the Zero Span Check and the Calibration Span Check was successfully passed.

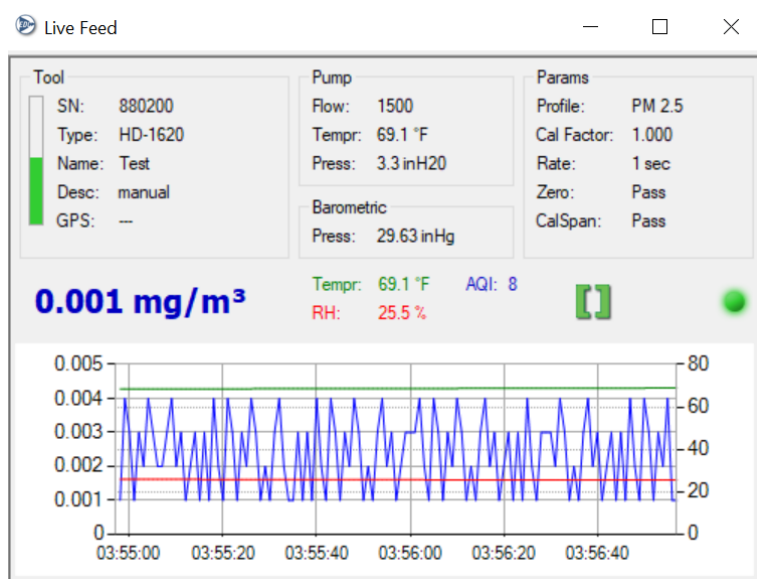

Change Units of Measurement

To change the units of measurement on the Live Feed, click on “Settings” then select “Options.” Choose desired options then press “OK” to confirm selection.

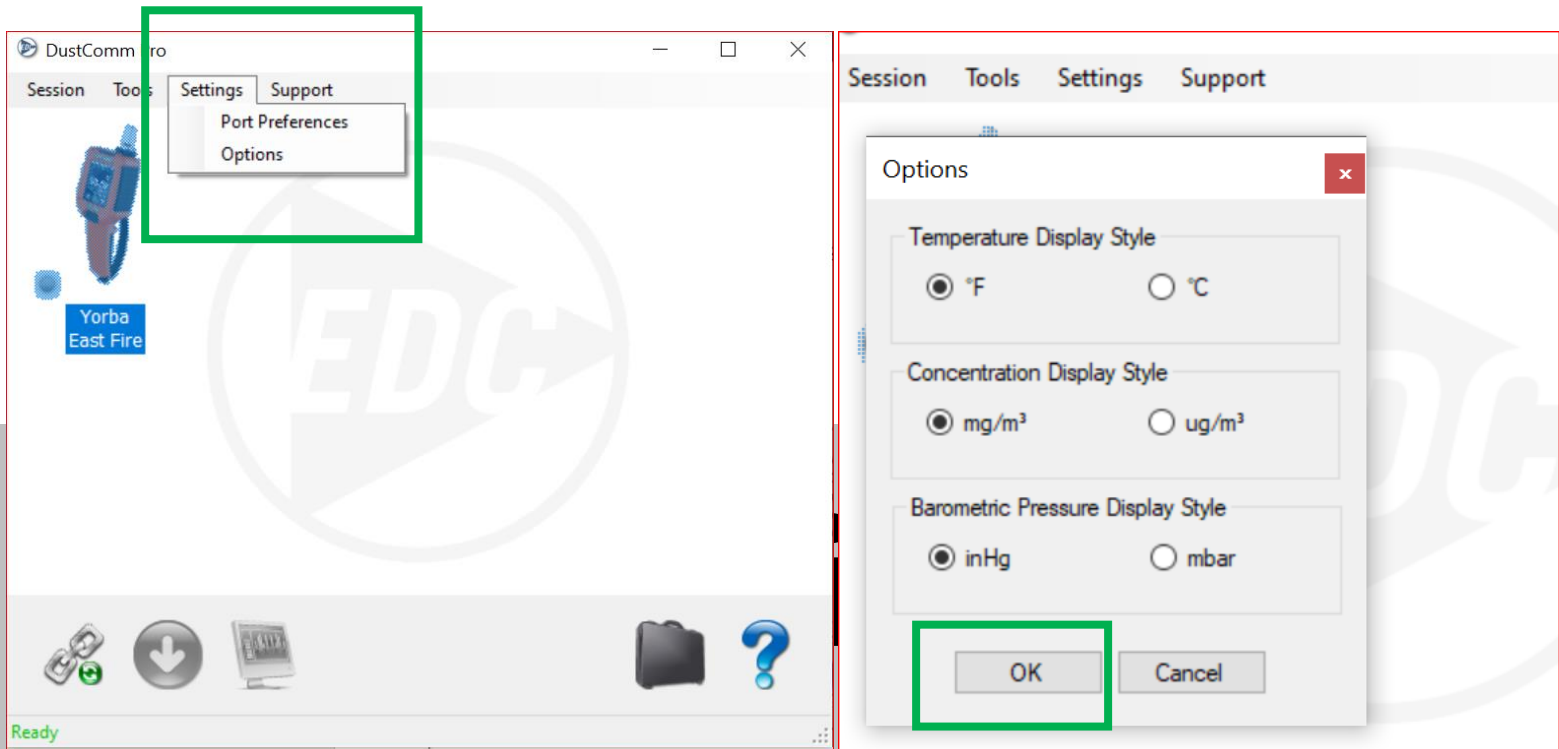

Appendix A

NIOSH/OSHA Particulate Air Monitoring Reference

Dust/Hazard	Agency	Reference	TWA	STEL
alpha-Alumina (Respirable fraction)	OSHA	CIM	5 mg/m ³	
alpha-Alumina (Total dust)	OSHA	CIM	15 mg/m ³	
Aluminum, Pyro powders	OSHA	CIM	*	
Aluminum (Respirable fraction)			5 mg/m ³	
Ammonium nitrate	OSHA	CIM	*	
Ammonium sulfamate (Respirable dust)	OSHA	CIM	5 mg/m ³	
Ammonium sulfamate (Total dust)	OSHA	CIM	15 mg/m ³	
Ammonium sulfamate (Total dust)	OSHA	ID 188	15 mg/m ³	
Bismuth telluride, Se-Doped	OSHA	ID 121	5 mg/m ³	
Bismuth telluride, Undoped (Respirable dust)	OSHA	ID 121	5 mg/m ³	
Bismuth telluride, Undoped (Total dust)	OSHA	CIM	15 mg/m ³	
Boron oxide (Total dust)	OSHA	ID 125G	15 mg/m ³	
Boron oxide (Total dust) (Particulates, Total)	NIOSH	0500	10 mg/m ³	
Carbon black	NIOSH	5000	3.5 mg/m ³	
Carbon black	OSHA	ID 196	3.5 mg/m ³	
Chromium, Metal & Insol cpds	OSHA	ID 121	1 mg/m ³	
Chromium, Metal & Insol cpds	OSHA	ID 125	1 mg/m ³	
Chrysene	OSHA	58	0.2 mg/m ³	
Coal dust (<than 5% SiO ₂)	OSHA	CIM	2.4 mg/m ³	
Coal dust (>than 5% SiO ₂)	OSHA	ID 142	10 mg/m ³	
Coal tar pitch volatiles	OSHA	58	0.2 mg/m ³	
* Refer to Agency Method				

Dust/Hazard	Agency	Reference	TWA	STEL
Copper dust	NIOSH	7029	1 mg/m ³	
Copper, Dusts & Mists	OSHA	ID 125G	1 mg/m ³	
Copper, Dusts & Mists	OSHA	ID 121	1 mg/m ³	
Copper (Elements)	NIOSH	7300	1 mg/m ³	
Copper fume	NIOSH	7029	0.1 mg/m ³	
Copper fume	OSHA	ID 121	0.1 mg/m ³	
Copper fume	OSHA	ID 125G	0.1 mg/m ³	
Cotton dust (Raw)	OSHA	CIM	1 mg/m ³	
Crag herbicide (Respirable dust)	OSHA	CIM	5 mg/m ³	
Crag herbicide (Total dust)	NIOSH	5(S356)	10 mg/m ³	
Crag herbicide (Total dust)	OSHA	CIM	15 mg/m ³	
Cresol, All isomers	NIOSH	2546	10 mg/m ³	
Cresol, All isomers	OSHA	32	15 mg/m ³	
Cyanide (as Cn)	OSHA	ID 120	5 mg/m ³	
Fluorides (Aerosol & Gas)	NIOSH	7902	2.5 mg/m ³	5.0 (HF)
Glass, Fibrous dust	OSHA	CIM	*	
Glycerin mist (Particulates)	NIOSH	0600	*	
Glycerin mist (Respirable)	OSHA	CIM	5 mg/m ³	
Glycerin mist (Total dust)	OSHA	CIM	15 mg/m ³	
Grain dust (Oats, Wheat & Barely)	OSHA	CIM	10 mg/m ³	
Graphite, Synthetic (Respirable dust)	OSHA	CIM	5 mg/m ³	
Graphite, Synthetic (Total dust)	OSHA	CIM	15 mg/m ³	
Iodine (Particulates)	OSHA	ID 212	*	0.1
Kaolin (Respirable dust)	OSHA	CIM	5 mg/m ³	
Kaolin (Total dust)	OSHA	CIM	15 mg/m ³	

Dust/Hazard	Agency	Reference	TWA	STEL
Lead	NIOSH	7082	<0.1 mg/m ³	
Lead	NIOSH	7105	<0.1 mg/m ³	
Lead	NIOSH	7700	<0.1 mg/m ³	
Lead (Elements)	NIOSH	7300	<0.1 mg/m ³	
Lead, Inorganic fumes & dusts (as Pb)	OSHA	ID 121	0.05 mg/m ³	
Lithium (Elements)	NIOSH	7300	*	
Lithium hydride	OSHA	CIM	25 µg/m ³	
Magnesium oxide fume (Total dust)	OSHA	ID 121	15 mg/m ³	
Manganese (Elements)	NIOSH	7300	1 mg/m ³	3 mg/m ³
Manganese fume (as Mn)	OSHA	ID 121	*	5 mg/m ³
Methoxychlor (Total Dust)	OSHA	CIM	15 mg/m ³	
Oil mist (Mineral)	OSHA	ID 128	5 mg/m ³	
Oil mist (Mineral)	OSHA	ID 178SG	5 mg/m ³	
Oil mist (Vegetable) (see Dust, Total and Respirable nuisance)				
Pentaerythritol (Total dust)	OSHA	CIM	15 mg/m ³	
Pentaerythritol (Respirable dust)	OSHA	CIM	5 mg/m ³	
Picloram (Tordon), Respirable dust	OSHA	CIM	5 mg/m ³	
Picloram (Tordon), Total dust	OSHA	CIM	15 mg/m ³	
Plaster of Paris (see Dust, Respirable nuisance)	OSHA	CIM		
Portland cement (Respirable dust)	OSHA	ID 142	5 mg/m ³	
Portland cement (Total dust)	OSHA	ID 142	15 mg/m ³	
Respirable nuisance	OSHA	CIM	5.0 mg/m ³	
Respirable nuisance (Particulates)	NIOSH	0600	*	

Dust/Hazard	Agency	Reference	TWA	STEL
Total nuisance	OSHA	CIM	15 mg/m ³	
Total nuisance (Particulates)	NIOSH	0500	10 mg/m ³	
Rouge (Respirable dust)	OSHA	CIM	5 mg/m ³	
Rouge (Total dust)	OSHA	CIM	15 mg/m ³	
Silica, Amorphous	OSHA	CIM	20 mppcf	
Silica, Crystalline tripoli, Respirable dust	OSHA	ID 142	0.05 mg/m ³	
Silicon carbide (Respirable dust)	OSHA	CIM	5 mg/m ³	
Silicon carbide (Total dust)	OSHA	CIM	15 mg/m ³	
Silicon (Respirable dust)	OSHA	CIM	5 mg/m ³	
Silicon (Total dust)	OSHA	CIM	15 mg/m ³	
Soapstone (Respirable dust)	OSHA	CIM	20 mppcf	
Soapstone (Total dust)	OSHA	CIM	6 mg/m ³	
Wood dust (except Western red cedar)	OSHA	CIM	*	
Wood dust (Western red cedar)	OSHA	CIM	2.5 mg/m ³	
Zinc bromide (see Dust, Total and Nuisance)			*	
Zinc oxide dust (see Dust, Total & Respirable)	OSHA	CIM		
Zinc oxide fume	OSHA	ID 121	5 mg/m ³	
Zinc oxide fume	OSHA	ID 125	5 mg/m ³	
Zinc oxide fume	OSHA	ID 143	5 mg/m ³	
Zinc stearate (Respirable dust)	OSHA	CIM	5 mg/m ³	
Zinc stearate (Total dust)	OSHA	ID 121	15 mg/m ³	
Zinc stearate (Total dust)	OSHA	ID 125	15 mg/m ³	
Zirconium cpds (as Zr)	OSHA	ID 121	5 mg/m ³	

Appendix B

Introduction

The tables below show the particle size cut point for Thoracic, Inhalable, and Respirable dust particles.

Particle Size Selections

Inhalable	
Particle Aerodynamic Diameter (μm)	Inhalable Particulate Mass (IPM) (%)
0	100
1	97
2	94
5	87
10	77
20	65
30	58
40	54.5
50	52.5
100	50

Respirable	
Particle Aerodynamic Diameter (μm)	Respirable Particulate Mass (RPM) (%)
0	100
1	97
2	91
3	74
4	50
5	30
6	17
7	9
8	5
10	1

Thoracic	
Particle Aerodynamic Diameter (μm)	Thoracic Particulate Mass (TPM) (%)
0	100
2	94
4	89
6	80.5
8	67
10	50*
12	35
14	23
16	15
18	9.5
20	6
25	2

*Same Cut Point as EPA PM-10

Particle Size-Selective

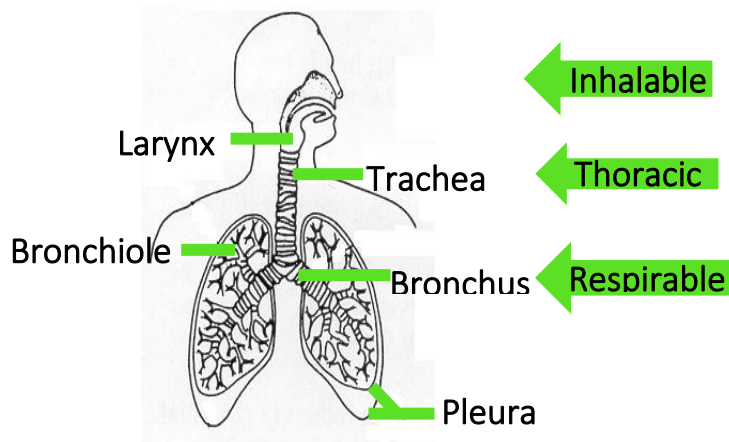

Appendix C

Glossary of Terms

Term	Definition/Standard
µm	Micron, 1/1000 of a meter.
ARD	Arizona Road Dust
Inhalable Dust Particulates	Particulates having a 50% cut point at 100µm.
LPM	Liters per minute.
mg/m ³	Milligrams per cubic meter.
NIOSH	National Institute of Occupational Safety & Health
OSHA	Occupational Safety & Health Administration.
Respirable Dust Particulates	Particulates having a 50% cut point at 3.5µm.
STEL	Short-term exposure level. Maximum dust concentration over a 15-minute period.
Thoracic Particulates	Particulates having a 50% cut point at 10µm.
TWA	Time Weighted Average. Average particulate concentration over a period.